



Wersja z wyrzutem poziomym (CTHB/CTHT)



Model od 140 do 400



Model od 450 do 710



CTVT HP
wersja standardowa

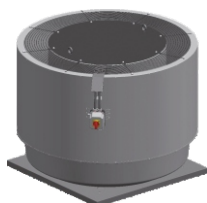

CTVT INS
wersja wyciszona akustycznie



Akcesoria

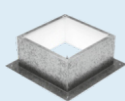

Podstawa dachowa JBS
str. 336

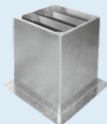

Podstawa tłumiąca JAA
str. 336



Kłapa zwrotna JCA
str. 337



Złącze JPA
str. 337



Króciec JBR
str. 337

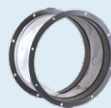

Złącze p-drg. JAE
str. 337



Reb 4 - Auto
str. 893



regulator REB
str. 892



regulator RMB, RMT
str. 892



higrostat HIG-2
str. 896



czujnik SQA
str. 896



termostat TS
str. 896



termostat TK-1
str. 896



presostat
str. 897

Zastosowanie

Wentylacja wywiewna magazynów, hal sklepowych i przemysłowych, budynków gospodarczych w rolnictwie, etc. Ze względu na wysoką odporność temperaturową zalecane zwłaszcza jako odciąg z nad rusztów, z okapów w przemyśle mięsny oraz gastronomii. Do odciągów pary wodnej i mgły z zanieczyszczeniami tłuszczowymi szczególnie polecane wentylatory z wyrzutem pionowym.

Konstrukcja

Wentylator dachowy przeznaczony do pracy ciągłej w wysokich temperaturach. Wszystkie modele przystosowane są do pracy ciągłej w temperaturze 120°C. Wentylatory dostosowane do pracy w wersjach F400 oraz F600 (od wielkości 225)*.

Wirnik z blachy galwanizowanej (140-400) lub z blachy stalowej malowanej (450-710) wyważony dynamicznie. Obudowa z blachy aluminiowej, podstawa z blachy stalowej galwanizowanej. Wentylatory (typ 140-400) są przystosowane do regulacji prędkości obrotowej.

Silnik elektryczny

Asynchroniczny, trójfazowy 380-420V, 50Hz lub 220-240V, 50Hz silnik jednofazowy z kondensatorem. Silniki są wykonane zgodnie ze standardem IEC 72 i IEC 34-1. Klasa izolacji F, stopień ochrony IP 55.

Schematy podłączenia elektrycznego:

- dla silników jednofazowych: rys. 4, str. 925 w modelach 140-225, rys. 5, str. 925 w modelach 250-400.

- dla silników trójfazowych: rys. 6, str. 925.

Wentylatory w wersji oddymiającej - str. 495.

* wykonania wentylatora w wersji F600 do konsultacji w Venture Industries.

Oznaczenia

CT V B / 4 - 140

Wielkość

Ilość biegunów (prędkość obrotowa):

4 ~1400 [obr./min]

6 ~950 [obr./min]

8 ~700 [obr./min]







































B silnik jednofazowy

T silnik trójfazowy

V wylot pionowy







































H wylot poziomy

Dane techniczne wentylatorów CTHB/CTHT (wylot poziomy)

Typ	prędkość obrotowa [obr./min]	pobór mocy max. [W]	natężenie [A]	wydajność max. [m³/h]	poziom ciśnienia akustycznego przy 2/3 Q _{max} *		masa [kg]	nr artykułu
					włot [dB(A)]	wylot [dB(A)]		
JEDNOFAZOWE 230V								
SILNIKI CZTEROBIEGUNOWE JEDNOFAZOWE								
CTHB/4-140	1370	60	0,32	800	46	52	7,5	43524010
CTHB/4-180	1330	70	0,33	990	46	52	8	43524020
CTHB/4-200	1320	120	0,6	1450	49	55	14,2	43524030
CTHB/4-225 	1350	170	0,9	2100	53	59	17	43524040
CTHB/4-250 	1320	280	1,4	3100	57	62	28	43524050
CTHB/4-315 	1375	590	2,7	4900	60	66	32	43524060
CTHB/4-400 	1380	1100	5,3	7000	67	73	42,5	43524070
SILNIKI SZEŚCIOBIEGUNOWE JEDNOFAZOWE								
CTHB/6-200 	940	80	0,4	970	38	45	14,2	43524110
CTHB/6-225 	890	90	0,4	1400	42	48	17	43524120
CTHB/6-250 	940	100	0,57	2000	45	52	28	43524130
CTHB/6-315 	840	170	0,81	3200	49	55	32	43524140
CTHB/6-400 	950	350	1,6	4500	56	62	42,5	43524150
TRÓJFAZOWE 400V								
SILNIKI CZTEROBIEGUNOWE TRÓJFAZOWE								
CTHT/4-140	1375	60	0,17	800	46	52	7,5	43524210
CTHT/4-180	1350	70	0,17	990	46	52	8	43524220
CTHT/4-200	1340	130	0,35	1450	49	55	14,2	43524230
CTHT/4-225 	1360	170	0,5	2100	53	59	17	43524240
CTHT/4-250 	1400	300	0,8	3100	57	62	28	43524250
CTHT/4-315 	1410	620	1,5	4900	60	66	32	43524260
CTHT/4-400 	1350	920	1,8	7000	67	73	42,5	43524270
CTHT/4-450 	1440	2300	4,6	10200	71	76	67	43524280
SILNIKI SZEŚCIOBIEGUNOWE TRÓJFAZOWE								
CTHT/6-200 	950	80	0,24	970	38	45	14,2	43524310
CTHT/6-225 	900	90	0,23	1400	42	48	17	43524320
CTHT/6-250 	950	100	0,41	2000	45	52	28	43524330
CTHT/6-315 	900	180	0,5	3200	49	55	32	43524340
CTHT/6-400 	925	350	1	4500	56	62	42,5	43524350
CTHT/6-450 	940	850	3,5	6900	59	66	67	43524360
CTHT/6-500 	950	1400	4,3	10500	63	69	104	43524370
CTHT/6-560 	950	2400	5,3	16000	66	73	118	43524380
CTHT/6-630 	950	3700	8,3	21000	70	76	156	43524390
CTHT/6-710 	980	6800	13,8	28900	77	83	217	43524400
SILNIKI OŚMIOBIEGUNOWE TRÓJFAZOWE								
CTHT/8-450 	700	700	2,1	5000	55	61	67	43524510
CTHT/8-500 	725	770	2,4	7500	55	62	104	43524520
CTHT/8-560 	730	1100	3,6	11500	58	65	118	43524530
CTHT/8-630 	735	1650	4,9	15000	62	69	156	43524540
CTHT/8-710 	730	2900	7,2	21700	70	76	226	43524550
SILNIKI DWUBIEGUNOWE TRÓJFAZOWE								
CTHT/4/8-225 	1300/700	180/70	0,3/0,2	2100/1050	53/38	59/44	17	43524245
CTHT/4/8-315 	1400/700	370/230	1,1/0,9	4900/2400	60/45	66/51	33	43524265
CTHT/4/8-400 	1400/700	1000/260	1,8/1,0	7000/3500	67/52	73/58	44	43524275
CTHT/4/8-450 	1400/700	2400/600	6,1/2,5	10200/5100	71/55	76/61	69	43524285
CTHT/6/12-450 	960/490	500/190	2/1	6900/3400	59/44	66/51	72	43524365
CTHT/6/12-500 	980/490	1520/430	4,5/2,2	10500/5300	63/48	69/54	109	43524375
CTHT/6/12-560 	950/480	2400/640	5,6/2,2	16000/7000	66/51	73/58	124	43524285
CTHT/6/12-630 	960/480	4100/730	8,1/2,6	21000/10500	70/55	76/61	161	43524395
CTHT/6/12-710 	950/450	6700/850	14,1/5,4	28900/15000	77/62	83/68	226	43524405

* Wartość poziomu ciśnienia akustycznego mierzona w dB(A) w odległości 1,5m, przy wydajności 2/3 Q_{max}

Dane techniczne wentylatorów CTVB/CTVT (wylot pionowy)

Typ	prędkość obrotowa [obr./min]	pobór mocy max. [W]	natężenie [A]	wydajność max. [m³/h]	poziom ciśnienia akustycznego przy 2/3 Q _{max} *		masa [kg]		nr artykułu
					wlot [dB(A)]	wylot [dB(A)]	F400	F600	
JEDNOFAZOWE 230V									
SILNIKI CZTEROBIEGUNOWE JEDNOFAZOWE									
CTVB/4-140	1375	60	0,3	725	46	49	10		43524610
CTVB/4-180	1330	60	0,3	830	46	49	10,5		43524620
CTVB/4-200	1330	100	0,6	1320	49	53	17		43524630
CTVB/4-225 	1350	130	0,71	1900	53	56	19,8		43524640
CTVB/4-250 	1325	325	1,6	2800	56	60	35		43524650
CTVB/4-315 	1390	570	2,7	4200	60	64	39		43524660
CTVB/4-400 	1390	1100	5,3	6250	67	70	50		43524670
SILNIKI SZĘŚCIOBIEGUNOWE JEDNOFAZOWE									
CTVB/6-200	940	80	0,4	900	38	42	17		43524710
CTVB/6-225 	890	90	0,4	1300	41	45	19,8		43524720
CTVB/6-250 	940	100	0,57	1850	45	49	35		43524730
CTVB/6-315 	870	160	0,8	280	48	53	39		43524740
CTVB/6-400 	960	340	1,6	4300	55	59	50		43524750
TRÓJFAZOWE 400V									
SILNIKI CZTEROBIEGUNOWE TRÓJFAZOWE									
CTVT/4-140	1400	60	0,18	750	46	49	10		43524810
CTVT/4-180	1350	60	0,18	830	46	49	10,5		43524820
CTVT/4-200	1340	130	0,44	1200	49	53	17		43524830
CTVT/4-225	1360	180	0,47	1900	53	56	19,8		43524840
CTVT/4-250 	1400	300	0,8	2800	56	60	35		43524850
CTVT/4-315 	1410	400	1,4	4200	60	64	39		43524860
CTVT/4-400 	1330	1000	1,8	6250	67	70	50		43524870
CTVT/4-450 	1440	2100	4,3	8850	70	74	75		43524880
NOWOŚĆ CTVT/4-632 HP 5,5KW 	1465	6100	10,9	18000		83	177	180	43529010
NOWOŚĆ CTVT/4-631 HP 7,5KW 	1480	6670	12,4	20700		85	180	190	43529030
NOWOŚĆ CTVT/4-712 HP 11KW 	1470	12250	21,3	26000		90	267	284	43529050
NOWOŚĆ CTVT/4-711 HP 15KW 	1480	16390	29,5	32500		90	303	310	43529070
NOWOŚĆ CTVT/4-802 HP 18,5KW 	1480	19850	34,5	35400		91	361	356	43529090
NOWOŚĆ CTVT/4-801 HP 22KW 	1485	26000	43,6	44500		94	376	383	43529110
NOWOŚĆ CTVT/4-632 5,5KW INS 	1465	6100	10,9	18000		70	221	224	43529020
NOWOŚĆ CTVT/4-631 7,5KW INS 	1480	6670	12,4	20700		77	224	234	43529040
NOWOŚĆ CTVT/4-712 11KW INS 	1470	12250	21,3	26000		82	357	374	43529060
NOWOŚĆ CTVT/4-711 15KW INS 	1480	16390	29,5	32500		83	393	400	43529080
NOWOŚĆ CTVT/4-802 18,5KW INS 	1480	19850	34,5	35400		83	492	487	43529100
NOWOŚĆ CTVT/4-801 22KW INS 	1485	26000	43,6	44500		87	507	514	43529120
SILNIKI SZĘŚCIOBIEGUNOWE TRÓJFAZOWE									
CTVT/6-200 	950	80	0,24	900	38	42	17		43524910
CTVT/6-225 	900	90	0,23	1300	41	45	19,8		43524920
CTVT/6-250 	950	100	0,41	1850	45	49	35		43524930
CTVT/6-315 	910	160	0,44	2800	48	53	39		43524940
CTVT/6-400 	930	350	1	4300	55	59	50		43524950
CTVT/6-450 	950	800	3,5	5900	59	63	75		43254960
CTVT/6-500 	975	1500	3,7	9500	62	66	115		43524970
CTVT/6-560 	950	2400	5,5	13000	66	70	129		43524980
CTVT/6-630 	950	3900	8,3	19500	70	74	168		43524990
CTVT/6-710 	980	7250	13,6	25200	74	72	229		43524993
SILNIKI OŚMIOBIEGUNOWE TRÓJFAZOWE									
CTVT/8-450	690	700	1,5	4400	55	59	75		43525010
CTVT/8-500 	700	770	2,4	7100	54	58	115		43525020
CTVT/8-560 	730	1100	3,3	10000	58	62	129		43525030
CTVT/8-630 	735	1650	4,9	14500	61	66	168		43525040
CTVT/8-710 	730	3160	7,1	19100	67	64	238		43525050

* Wartość poziomu ciśnienia akustycznego mierzona w dB(A) w odległości 1,5m, przy wydajności 2/3 Q_{max}

Dane techniczne wentylatorów CTVB/CTVT (wylot pionowy)

Typ	prędkość obrotowa [obr./min]	pobór mocy max. [W]	natężenie [A]	wydajność max. [m³/h]	poziom ciśnienia akustycznego przy 2/3 Q _{max} *		masa [kg]	nr artykułu
					włot [dB(A)]	wylot [dB(A)]		
SILNIKI DWUBIEGOWE TRÓJFAZOWE								
CTVT/4/8-225	1300/700	180/70	0,3/0,2	2100/1050	53/38	59/44	17	43524845
CTVT/4/8-315	1400/700	370/320	1,1/0,9	4700/2100	60/45	64/49	40	43524865
CTVT/4/8-400	1400/700	560/260	1,3/1,1	6800/3300	67/52	70/55	52	43524875
CTVT/4/8-450	1400/700	2400/600	6,1/2,5	10000/4500	70/55	74/59	77	43524885
CTVT/6/12-450	960/490	500/190	2/1	6300/2800	59/44	63/48	80	43524965
CTVT/6/12-500	980/490	1520/340	4,5/2,2	10000/4800	62/47	66/51	134	43524975
CTVT/6/12-560	960/480	2400/640	5,6/2,2	13000/6400	66/51	70/55	134	43524985
CTVT/6/12-630	960/480	4100/730	8,1/2,6	19500/9500	70/54	74/59	173	43524995
CTVT/6/12-710	950/450	7300/435	14/5,4	25200/12700	77/63	82/67	238	43524996

* Wartość poziomu ciśnienia akustycznego mierzona w dB(A) w odległości 1,5m, przy wydajności 2/3 Q_{max}

Wymiary [mm]

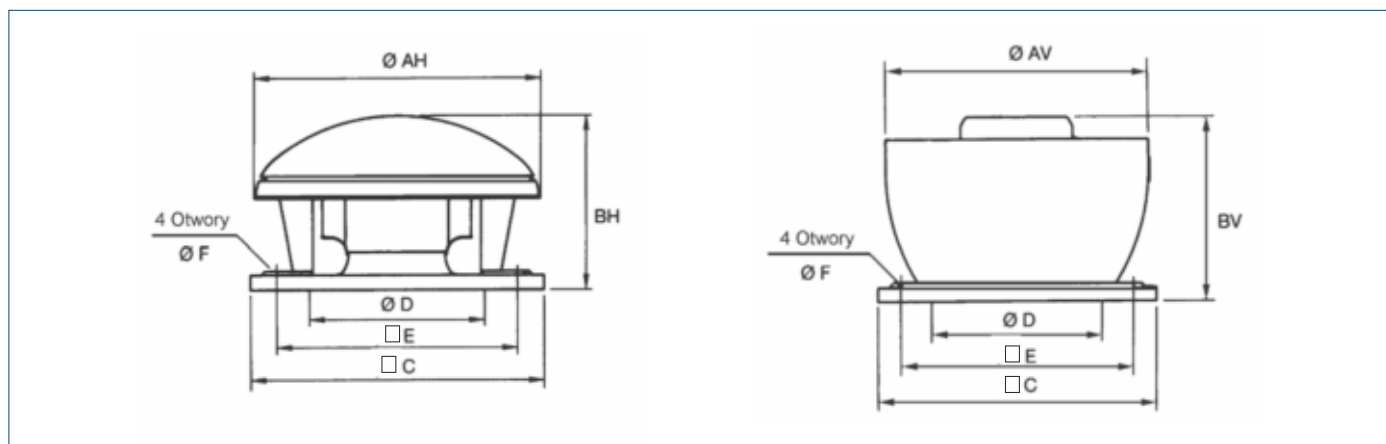

Typ	ØAH	ØAV	BH	BV	□C	ØD*	□E	ØF
140	415	421	277	359	300	180	245	10
180	415	421	292	374	300	180	245	10
200	561	556	340	404	435	250	330	12
225	561	570	383	452	435	250	330	12
250	762	750	425	522	560	355	450	12
315	762	750	469	564	560	355	450	12
400	850	850	532	608	630	400	535	12
450	962	950	713	741	710	500	590	14
500	1214	1216	824	832	905	630	750	14
560	1214	1216	874	832	905	630	750	14
630	1336	1327	1029	1053	1100	710	840	14
710	1336	1485	1127	1161	1100	710	840	14
632		1216		930	905		750	
631		1216		930	905		750	
712		1485		1146	1270		950	
711		1485		1188	1270		950	
802		1485		1207	1270		950	
801		1485		1225	1270		950	
632 INS		1342		978	905		750	
631 INS		1342		978	905		750	
712 INS		1611		1163	1270		950	
711 INS		1611		1250	1270		950	
802 INS		1611		1274	1270		950	
801 INS		1611		1292	1270		950	

* - Nominalna średnica sugerowanego przewodu wentylacyjnego

Montaż

Typ	podstawa dachowa 1	podstawa tłumiąca 2	złącze JPA 3	kłapa zwrotna 4	króciec JBR 5	złącze JAE 6
140	RS-300 / JBS-300	RSA-300 / JAA-300	JPA-300	JCA-300	JBR-300	JAE-300
180	RS-300 / JBS-300	RSA-300 / JAA-300	JPA-300	JCA-300	JBR-300	JAE-300
200	RS-435 / JBS-435	RSA-435 / JAA-435	JPA-435	JCA-435	JBR-435	JAE-435
225	RS-435 / JBS-435	RSA-435 / JAA-435	JPA-435	JCA-435	JBR-435	JAE-435
250	RS-560 / JBS-560	RSA-560 / JAA-560	JPA-560	JCA-560	JBR-560	JAE-560
315	RS-560 / JBS-560	RSA-560 / JAA-560	JPA-560	JCA-560	JBR-560	JAE-560
400	RS-630 / JBS-630	RSA-630 / JAA-630	JPA-630	JCA-630	JBR-630	JAE-630
450	RS-710 / JBS-710	RSA-710 / JAA-710	JPA-710	JCA-710	JBR-710	JAE-710
500	RS-905 / JBS-905	RSA-905 / JAA-905	JPA-905	JCA-905	JBR-905	JAE-905
560	RS-905 / JBS-905	RSA-905 / JAA-905	JPA-905	JCA-905	JBR-905	JAE-905
630	RS-1100 / JBS-1100	RSA-1100 / JAA-1100	JPA-1100	JCA-1100	JBR-1100	JAE-1100
710	RS-1100 / JBS-1100	RSA-1100 / JAA-1100	JPA-1100	JCA-1100	JBR-1100	JAE-1100
632	RS-905 / JBS-905	RSA-905 / JAA-905	JPA-905	JCA-905	JBR-905	JAE-905
631	RS-905 / JBS-905	RSA-905 / JAA-905	JPA-905	JCA-905	JBR-905	JAE-905
712	JBS-1250	JAA-1250		JCA-1250		JAE-1250
711	JBS-1250	JAA-1250		JCA-1250		JAE-1250
802	JBS-1250	JAA-1250		JCA-1250		JAE-1250
801	JBS-1250	JAA-1250		JCA-1250		JAE-1250

Podstawy JBS i JAA dedykowane dla wentylacji oddymiającej.

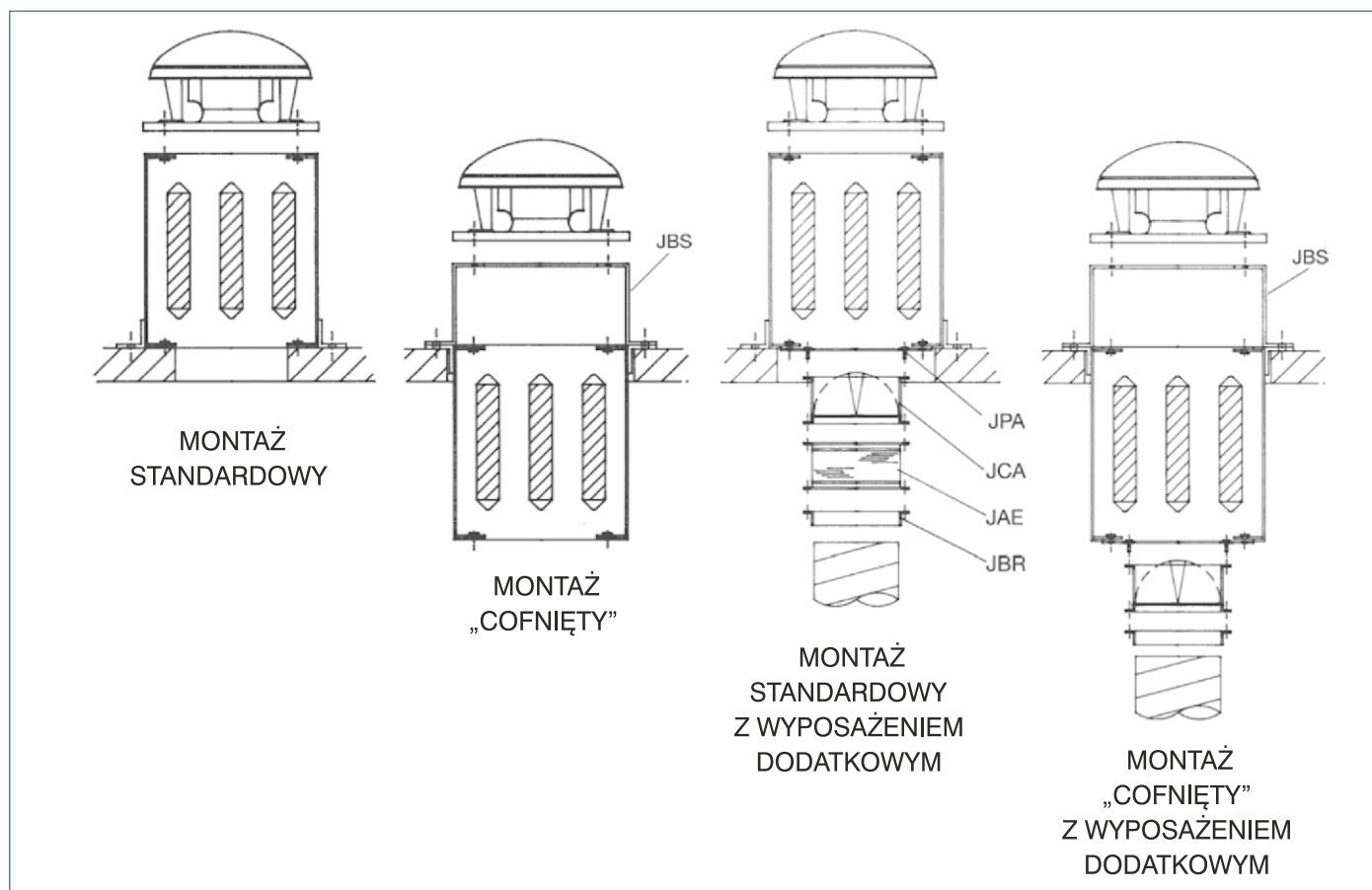
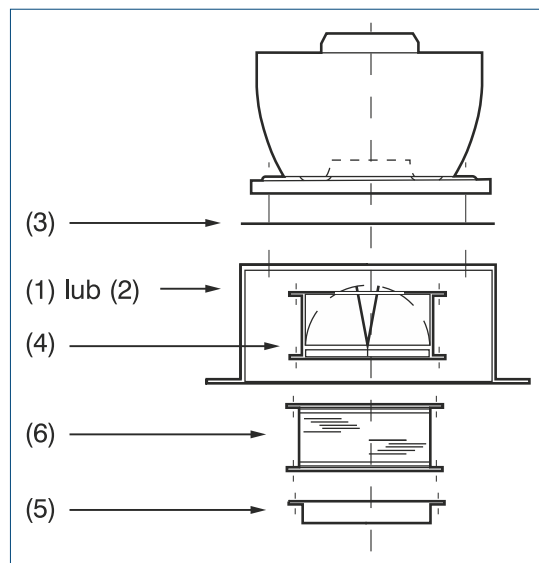

Widmo akustyczne oblicza się odejmując współczynniki korekcyjne przedstawione w poniższych tabelach od wartości z tabeli z danymi technicznymi.

Typ		częstotliwość w HZ						
		125	250	500	1000	2000	4000	8000
NA WYLOCIE	Q _{max}	2	7,5	11	11	9	6	0,5
	2/3 Q _{max}	-0,5	3,5	5,5	5,5	3,5	0,5	-4,5
	1/3 Q _{max}	-2,5	1,5	3,5	3,5	1,5	-1,5	-6,5
NA WLOCIE	Q _{max}	5,5	9	11,5	11	10	7,5	3,5
	2/3 Q _{max}	2,5	5	6	4,5	1,5	-2,5	-8,6
	1/3 Q _{max}	0,5	3	4	2,5	-0,5	-4,5	-10,5

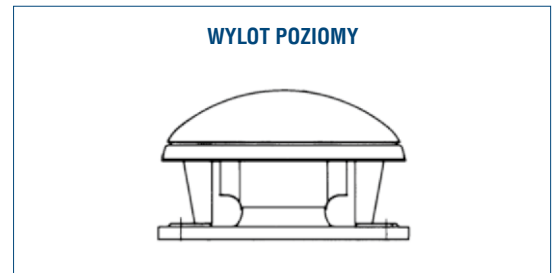

Typ		częstotliwość w HZ						
		125	250	500	1000	2000	4000	8000
NA WYLOCIE	Q _{max}	3	8	11,5	11,5	8	1,5	-8,0
	2/3 Q _{max}	0,5	4,5	6,5	5	1,5	-3,0	-10,0
	1/3 Q _{max}	-1,5	2,5	4,5	3	-0,5	-5,0	-12,0
NA WLOCIE	Q _{max}	4,5	9	10,5	8,5	6,5	5,5	3
	2/3 Q _{max}	3	5	6	4,5	1	-3,0	-9,5
	1/3 Q _{max}	1	3	4	2,5	-1,0	-5,0	-11,5



Widmo akustyczne

Ciśnienie akustyczne w odległości "d" obliczyć odejmując od każdego pasma częstotliwości widma akustycznego wartość korekty z poniższej tabeli.

ODLEGŁOŚĆ [d]	1 m	1,5 m	4 m	6 m	10 m	15 m	20 m	30 m
KOREKTA [dB]	11	14,5	23	26	31	34	37	40

CTVT/4-632	63	125	250	500	1000	2000	4000	8000	STD*	INS**	
50Hz	LP	78	85	96	93	93	95	87	77	101	87
	MP	74	84	95	90	90	90	82	73	98	88
	HP	75	83	94	90	90	89	81	75	98	87
40Hz	LP	73	80	91	88	88	90	83	72	96	83
	MP	69	79	90	86	85	85	77	68	93	83
	HP	70	78	89	85	85	84	76	70	93	83
30Hz	LP	67	74	85	82	82	84	76	66	90	76
	MP	63	73	84	79	79	78	71	62	87	76
	HP	64	72	83	79	79	78	70	63	87	76
25Hz	LP	63	70	81	78	78	80	72	62	86	72
	MP	59	69	80	75	75	74	67	58	83	73
	HP	60	68	79	75	75	74	66	59	83	72

* STD - wersja standardowa ** INS - wersja wyciszona akustycznie

CTVT/4-631	63	125	250	500	1000	2000	4000	8000	STD*	INS**	
50Hz	LP	71	79	95	93	94	99	93	83	103	94
	MP	69	79	95	92	94	94	86	81	100	96
	HP	68	78	95	90	92	89	82	79	98	98
40Hz	LP	66	74	90	88	89	94	88	78	98	90
	MP	64	74	90	87	89	89	81	76	95	91
	HP	63	73	90	85	87	84	77	74	93	93
30Hz	LP	60	68	84	82	83	88	82	72	92	83
	MP	58	68	84	81	83	83	75	70	89	85
	HP	57	67	84	79	81	78	71	68	87	87
25Hz	LP	56	64	80	78	79	84	78	68	88	79
	MP	54	64	80	77	79	79	71	66	85	81
	HP	53	63	80	75	77	74	67	64	83	83

* STD - wersja standardowa ** INS - wersja wyciszona akustycznie

CTVT/4-712	63	125	250	500	1000	2000	4000	8000	STD*	INS**	
50Hz	LP	78	90	97	100	102	102	97	88	107	100
	MP	74	86	93	96	98	94	88	80	102	94
	HP	73	87	90	93	94	89	83	75	98	89
40Hz	LP	73	85	92	95	97	97	93	83	102	95
	MP	69	81	88	91	94	89	84	75	97	89
	HP	68	83	85	88	89	84	79	71	94	85
30Hz	LP	67	79	86	88	91	91	86	77	96	89
	MP	63	74	81	85	87	83	77	69	91	83
	HP	62	76	79	82	83	78	72	64	87	78
25Hz	LP	63	75	82	85	87	87	82	73	92	85
	MP	59	70	77	81	83	79	73	65	87	79
	HP	58	72	75	78	79	74	68	60	83	74

* STD - wersja standardowa ** INS - wersja wyciszona akustycznie

CTVT/4-711	63	125	250	500	1000	2000	4000	8000	STD*	INS**	
50Hz	LP	78	88	100	101	101	101	98	89	107	100
	MP	73	88	97	96	96	91	93	81	102	94
	HP	69	86	95	93	93	88	89	77	100	91
40Hz	LP	74	84	95	96	96	96	94	84	102	95
	MP	69	83	92	91	92	87	88	76	98	89
	HP	65	81	90	88	89	84	84	72	95	86
30Hz	LP	67	77	89	90	90	90	87	78	96	89
	MP	62	77	86	85	85	80	82	70	91	83
	HP	58	75	84	82	82	77	78	66	89	80
25Hz	LP	63	73	85	86	86	86	83	74	92	85
	MP	58	73	82	81	81	76	78	66	87	79
	HP	54	71	80	78	78	73	74	62	85	76

* STD - wersja standardowa ** INS - wersja wyciszona akustycznie

Charakterystyka akustyczna

CTVT/4-802	63	125	250	500	1000	2000	4000	8000	STD*	INS**
50Hz LP	79	90	97	101	102	103	99	90	108	101
50Hz MP	75	86	93	99	98	96	91	82	103	97
50Hz HP	74	87	90	96	94	91	86	79	100	94
40Hz LP	74	86	92	97	97	99	95	85	103	96
40Hz MP	70	82	89	94	93	91	86	77	99	92
40Hz HP	69	82	86	91	89	87	82	74	95	90
30Hz LP	68	79	85	90	91	92	88	79	97	90
30Hz MP	64	75	82	88	87	85	80	71	92	86
30Hz HP	63	76	79	85	83	80	75	68	89	89
25Hz LP	64	75	82	86	87	88	84	75	93	86
25Hz MP	60	71	78	84	83	81	76	67	88	82
25Hz HP	59	72	75	81	79	76	71	64	85	79

* STD - wersja standardowa ** INS - wersja wyciszona akustycznie

CTVT/4-801	63	125	250	500	1000	2000	4000	8000	STD*	INS**
50Hz LP	80	93	101	104	108	103	101	89	112	104
50Hz MP	79	90	98	101	106	100	94	85	108	102
50Hz HP	76	89	93	98	102	94	86	81	104	98
40Hz LP	76	88	96	99	104	98	96	84	107	99
40Hz MP	74	85	93	96	101	95	89	80	104	97
40Hz HP	71	84	88	93	97	90	82	76	99	93
30Hz LP	69	82	90	92	97	92	90	78	100	93
30Hz MP	68	79	87	90	95	89	83	74	97	91
30Hz HP	65	78	82	87	90	83	75	70	93	87
25Hz LP	65	78	86	88	93	88	86	74	96	89
25Hz MP	64	75	83	86	91	85	79	70	93	87
25Hz HP	61	74	78	83	87	79	71	66	89	83

* STD - wersja standardowa ** INS - wersja wyciszona akustycznie

Charakterystyki pracy

Wartości dźwięku podane na wykresach są wielkościami ciśnienia akustycznego mierzonymi w odległości 1,5 m od wlotu wentylatora.

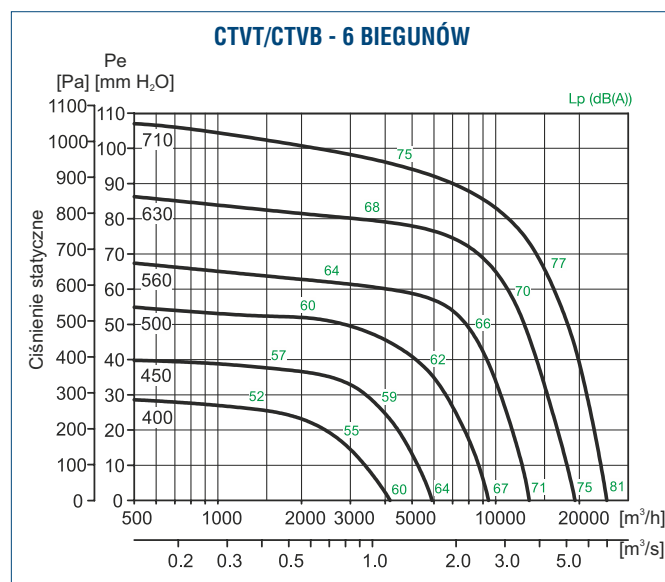
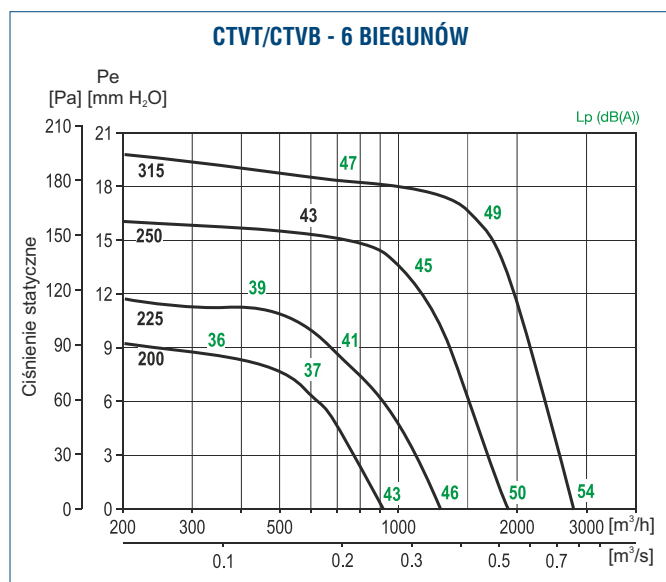
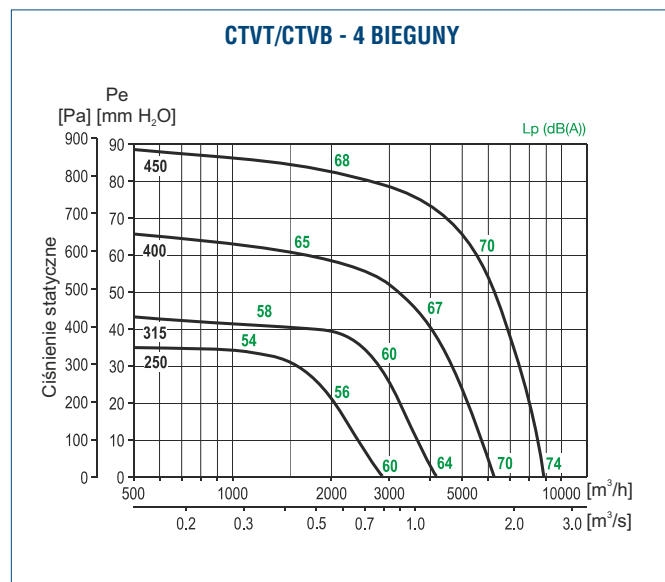
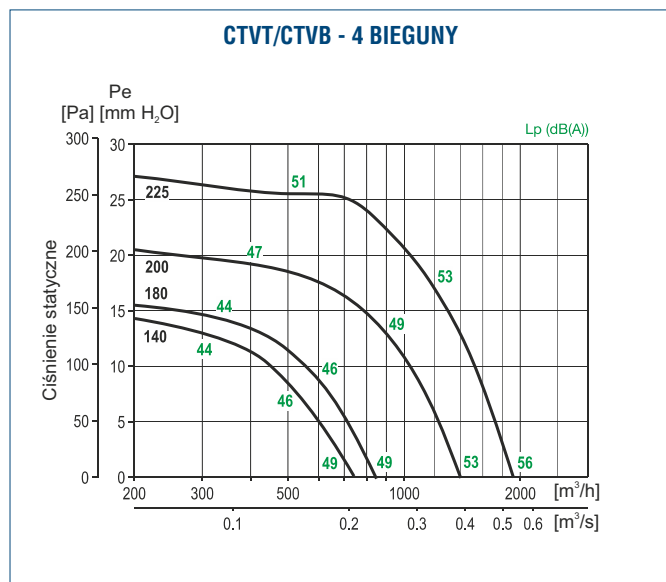

Charakterystyki pracy

Wartości dźwięku podane na wykresach są wielkościami ciśnienia akustycznego mierzonymi w odległości 1,5 m od wlotu wentylatora.

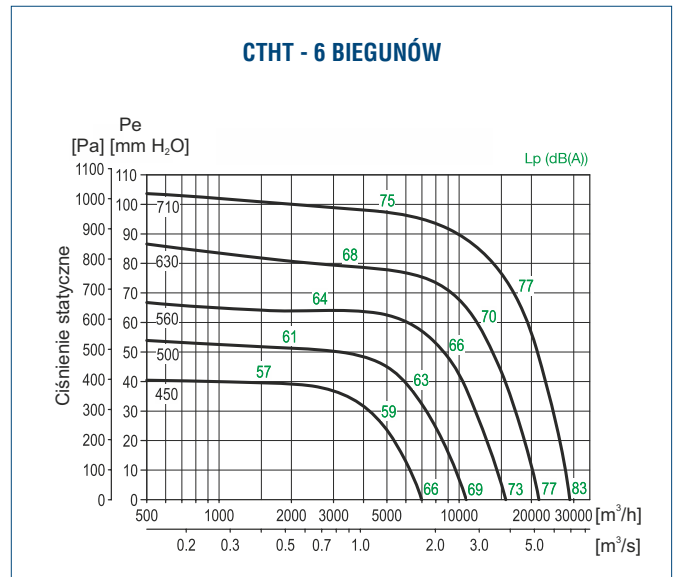
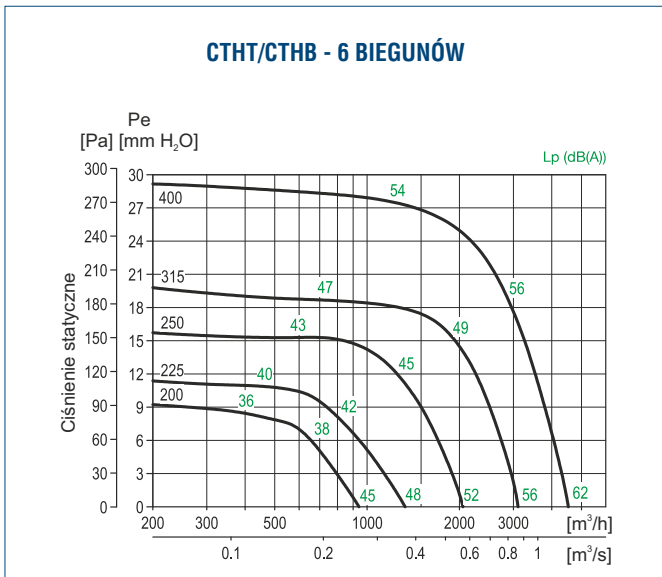
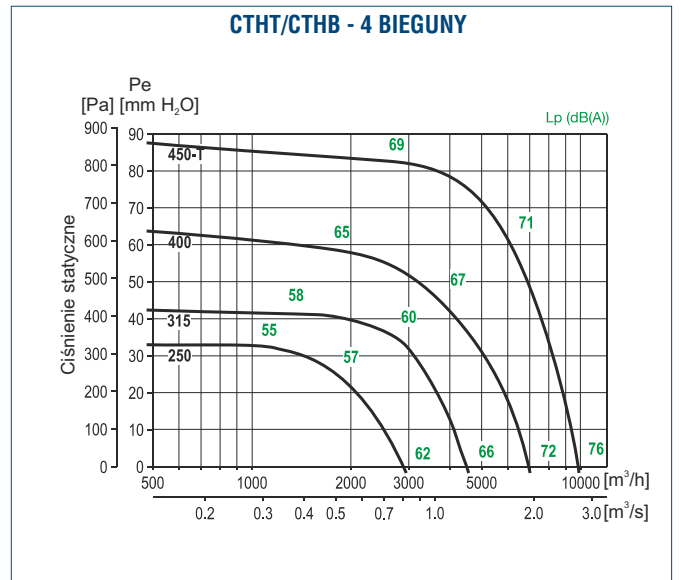
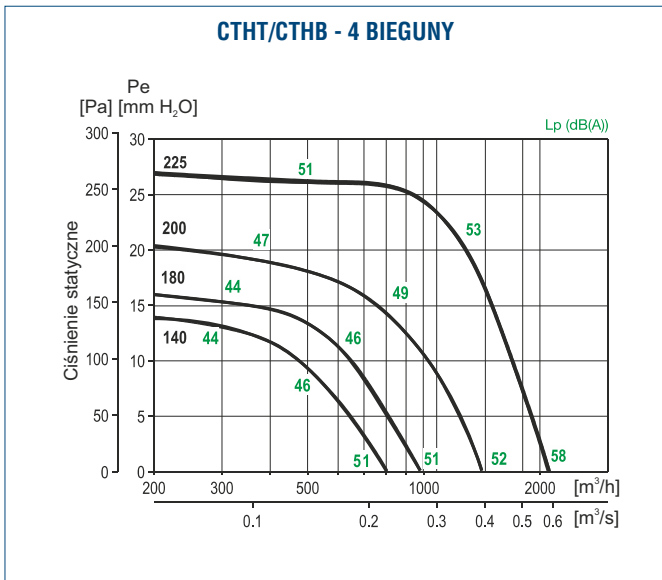
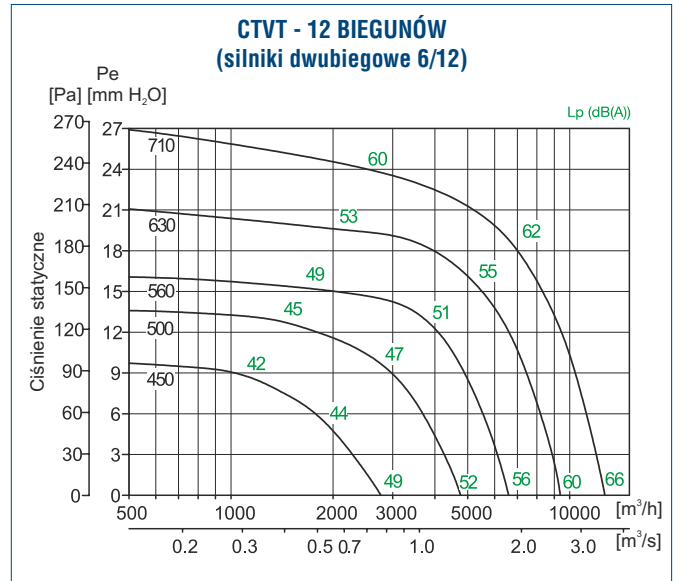
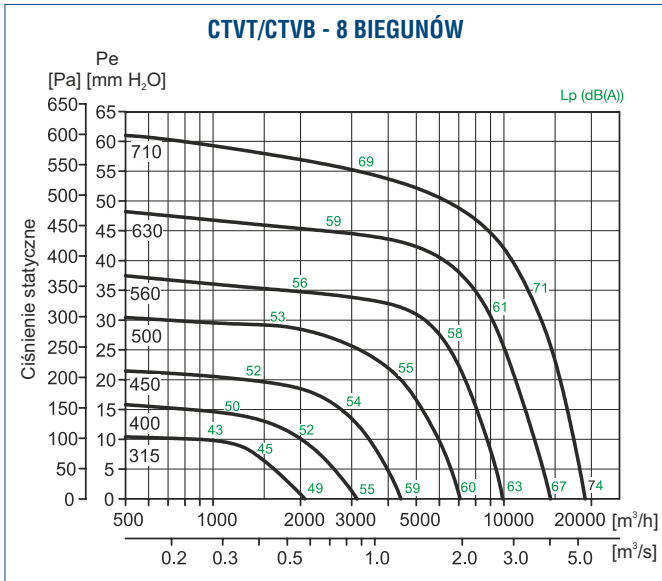

Charakterystyki pracy

Wartości dźwięku podane na wykresach są wielkościami ciśnienia akustycznego mierzonymi w odległości 1,5 m od wlotu wentylatora.

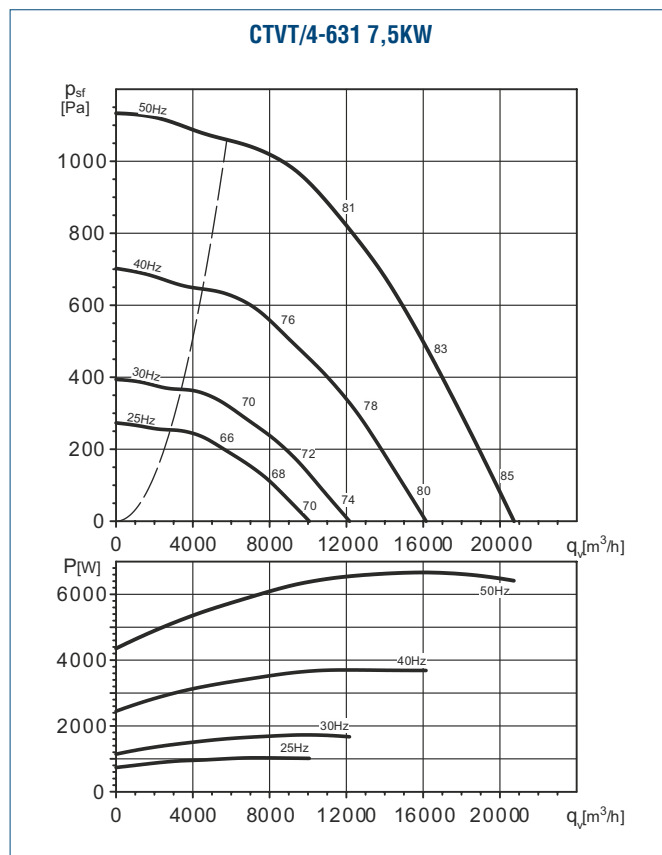
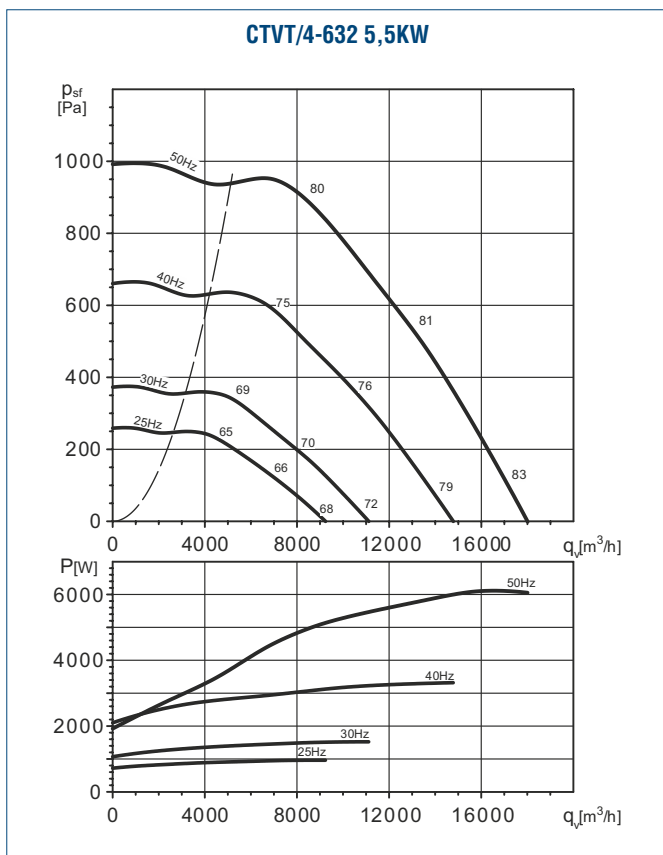
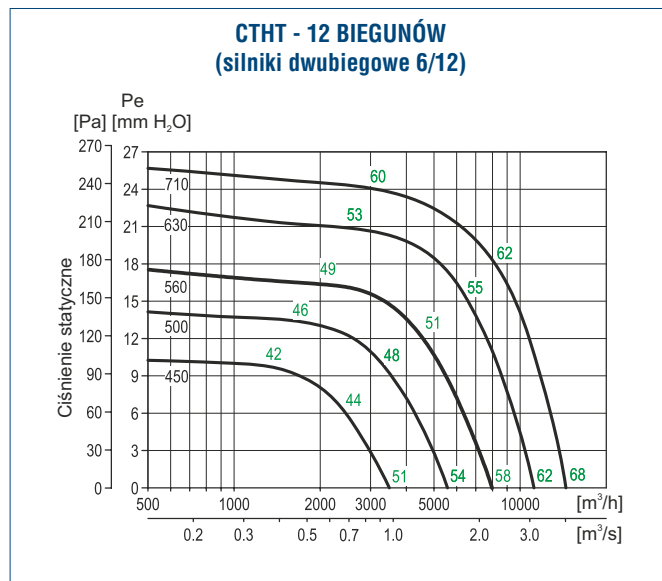
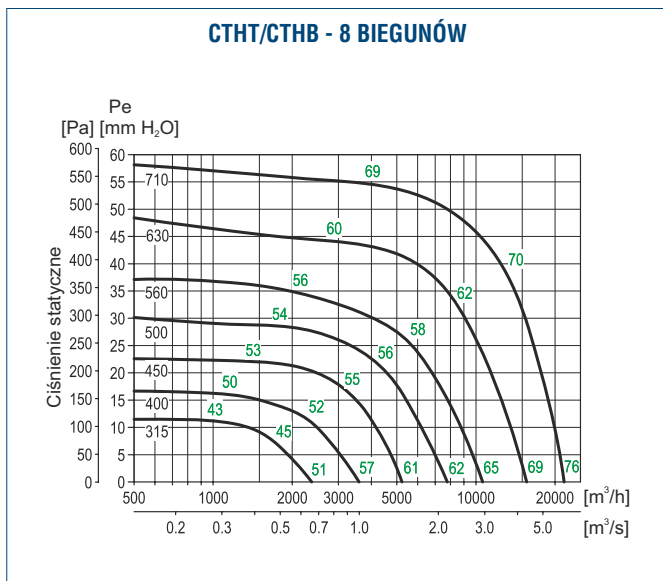

Charakterystyki pracy

Wartości dźwięku podane na wykresach są wielkościami ciśnienia akustycznego mierzonymi w odległości 1,5 m od wlotu wentylatora.

