

WYWIEW



NAWIEW



Zastosowanie

Wentylacja nawiewna lub wywiewna magazynów, hal sklepowych i przemysłowych, budynków gospodarczych w rolnictwie, kuchni przemysłowych, etc.

Konstrukcja

Wentylator dachowy osiowy z wylotem poziomym. Dostępny w dwóch wersjach: nawiewnej "A" i wywiewnej "B". Podstawa wykonana z galwanizowanej blachy stalowej. Pokrywa wykonana z tłocznej blachy aluminiowej. Wirnik odlany w całości z tworzywa sztucznego wzmocnianego włóknem szklanym (modele od 315 do 400) lub składany z łopatek z tworzywa mocowanych na piaście aluminiowej (modele od 630 do 1000). Temperatura pracy od -40°C do +70°C (-20°C do +40°C dla modeli 800-1000).

Wersje przeciwybuchowe zgodne z dyrektywą ATEX dostępne na życzenie:

- wersje wzmocnione II2G EexellT3
- wersje ogniotrwałe (tylko dla modeli 800, 900, 1000 z silnikami 4- lub 6-biegunowymi) II2G EexdII BT5 lub EexdII CT4.

Silnik elektryczny

Wentylatory wyposażone są w asynchroniczne silniki, jednofazowe 230V, 50Hz lub trójfazowe 400V 50Hz. Klasa izolacji F, IP 65 (z wyjątkiem modeli 800 do 1000). Termiczne zabezpieczenie przed przeciążeniem (z wyjątkiem modeli 800 do 1000). Silniki są przystosowane do napięciowej regulacji prędkości obrotowej w modelach do 630 włącznie (z wyjątkiem modeli HCTB/4-560, HCTB/4-630). Trójfazowe modele mogą być przełączane Y/Δ przy zasilaniu 380-415V, 50Hz co umożliwia pracę z dwoma prędkościami obrotowymi. Silniki do regulacji napięciowej z wyjątkiem modeli /4-560. /4-630 oraz 710 do 1000. Modele trójfazowe od 800 do 1000 przystosowane do regulacji falownikiem.

Schemat podłączenia elektrycznego:

dla silników jednofazowych: rys. 9 str. 776 w modelach 315-400, rys. 9a str. 776 w modelach 450-630 dla silników trójfazowych: rys. 10 str. 776.

Dane techniczne dla wentylatorów wywiewnych (typ B)

Typ	prędkość obrotowa [obr./min]	pobór mocy max. [W]	natężenie max. [A]		wydajność max.		poziom ciśnienia akustycznego w odległości 1,5*		masa [kg]	regulator	nr artykułu
			230V	400V	wyższa pręđ. [m³/h]	niższa pręđ. [m³/h]	wlot [dB(A)]	wylot [dB(A)]			
JEDNOFAZOWE 230V											
JEDNOFAZOWE 4 BIEGUNOWE											
HCTB/4-315-B	1300	100	0,59	-	1930	-	59	58	14,4	REB-1	43525620
HCTB/4-355-B	1255	200	0,96	-	2680	-	56	55	15,8	REB-1	43525630
HCTB/4-400-B	1290	340	1,64	-	3700	-	59	58	16,5	REB-2,5	43525640
HCTB/4-450-B	1290	480	2,3	-	5600	-	62	61	23,5	REB-2,5	43525650
HCTB/4-500-B	1290	650	3	-	7100	-	69	67	25,5	REB-5	43525660
HCTB/4-560-B	1200	980	4,9	-	9820	-	73	69	40	-	43525670
HCTB/4-630-B	1290	1700	7,6	-	13000	-	74	70	42,6	-	43525680
JEDNOFAZOWE 6 BIEGUNOWE											
HCTB/6-450-B	835	220	1,15	-	3900	-	53	52	23,5	REB-1	43525690
HCTB/6-500-B	840	290	1,6	-	4600	-	56	54	25,4	REB-2,5	43525700
HCTB/6-560-B	900	420	2,4	-	6850	-	60	58	40	REB-2,5	43525710
HCTB/6-630-B	800	510	2,56	-	8400	-	64	61	42,6	REB-5	43525720

* Wentylator umieszczony na dachu.

** Moc absorbowana.

Akcesoria



Dane techniczne dla wentylatorów wywiewnych (typ B)

Typ	prędkość obrotowa [obr./min]	pobór mocy max. [W]	natężenie max. [A]		wydajność max.		poziom ciśnienia akustycznego w odległości 1,5*		masa [kg]	regulator	nr artykułu
			230V	400V	wyższa pręđ. [m³/h]	niższa pręđ. [m³/h]	włot [dB(A)]	wylot [dB(A)]			
TRÓJFAZOWE 400V											
TRÓJFAZOWE 4 BIEGUNOWE											
HCTT/4-315-B	1300	150	-	0,34	1930	1500	59	58	14,4	RMT-1,5	43525730
HCTT/4-355-B	1260	200	-	0,46	2680	2000	56	55	15,8	RMT-1,5	43525740
HCTT/4-400-B	1350	300	-	0,8	3700	2900	59	58	16,5	RMT-1,5	43525750
HCTT/4-450-B	1230	500	-	1	5600	4500	63	61	23,5	RMT-1,5	43525760
HCTT/4-500-B	1350	660	-	1,6	7100	5850	69	67	25,4	RMT-2,5	43525770
HCTT/4-560-B	1320	1210	-	2,3	9820	7600	73	69	40	-	43535780
HCTT/4-630-B	1290	1600	-	3,2	13000	-	74	70	42,6	-	43535790
HCTT/4-710-B	1300	2200	-	4	18400	-	82	80	60	-	43535800
HCTT/4-800-B	1400	3 kW**	-	7,3	23800	-	89	86	67	falownik	43535810
HCTT/4-900-B	1400	4 kW**	-	9,5	30000	-	92	89	77	falownik	43525820
HCTT/4-1000-B	1450	5,5 kW**	-	12	38500	-	93	90	123	falownik	43525610
TRÓJFAZOWE 6 BIEGUNOWE											
HCTT/6-450-B	835	190	-	0,48	3900	3000	53	62	23,5	RMT-1,5	43525830
HCTT/6-500-B	830	250	-	0,57	4600	3500	56	54	25,4	RMT-1,5	43525840
HCTT/6-560-B	850	410	-	0,93	6850	5400	60	58	40	RMT-1,5	43525850
HCTT/6-630-B	810	600	-	1,18	8400	6400	64	61	42,6	RMT-1,5	43525860
HCTT/6-710-B	900	1100	-	3,3	12700	-	72	70	54	-	43525870
HCTT/6-800-B	930	0,75 kW**	-	2,5	15800	-	79	76	57	falownik	43525880
HCTT/6-900-B	930	1,1 kW**	-	3,5	20000	-	82	79	67	falownik	43525890
HCTT/6-1000-B	930	1,5 kW**	-	4,5	24700	-	83	80	108	falownik	43525900
TRÓJFAZOWE 8 BIEGUNOWE											
HCTT/8-710-B	670	370	-	1,2	9500	-	64	62	52	-	43525910
HCTT/8-800-B	700	370	-	1,9	11900	-	71	68	57	falownik	43525920
HCTT/8-900-B	700	550	-	2,3	15000	-	74	71	67	falownik	43525930
HCTT/8-1000-B	700	750	-	2,8	18600	-	75	72	108	falownik	43525940

* Wentylator umieszczony na dachu.

** Moc absorbowana.

Dane techniczne dla wentylatorów nawiewnych (typ A)

Typ	prędkość obrotowa [obr./min]	pobór mocy max. [W]	natężenie max. [A]		wydajność max.		poziom ciśnienia akustycznego w odległości 1,5*		masa [kg]	regulator	nr artykułu
			230V	400V	wyższa pręđ. [m³/h]	niższa pręđ. [m³/h]	włot [dB(A)]	wylot [dB(A)]			
JEDNOFAZOWE 230V											
JEDNOFAZOWE 4 BIEGUNOWE											
HCTB/4-315-A	1300	100	0,54	-	2150	-	58	64	14,4	REB-1	43525620-01
HCTB/4-355-A	1255	200	0,96	-	3250	-	59	61	15,8	REB-1	43525630-01
HCTB/4-400-A	1200	340	1,64	-	4720	-	64	68	16,5	REB-2,5	43525640-01
HCTB/4-450-A	1290	480	2,3	-	6670	-	68	73	23,5	REB-2,5	43525650-01
HCTB/4-500-A	1290	650	3,1	-	8440	-	72	76	25,4	REB-5	43525660-01
HCTB/4-560-A	1250	980	4,9	-	11400	-	75	80	40	-	43525670-01
HCTB/4-630-A	1200	1700	7,6	-	15300	-	79	84	42,6	-	43525680-01
JEDNOFAZOWE 6 BIEGUNOWE											
HCTB/6-450-A	835	220	1,1	-	4400	-	56	60	23,5	REB-1	43525690-01
HCTB/6-500-A	840	290	1,5	-	5500	-	60	63	25,4	REB-2,5	43525700-01
HCTB/6-560-A	900	420	2,3	-	7900	-	64	68	40	REB-2,5	43525710-01
HCTB/6-630-A	900	510	2,5	-	9900	-	66	70	42,6	REB-5	43525720-01

Dane techniczne dla wentylatorów nawiewnych (typ A)

Typ	prędkość obrotowa [obr./min]	pobór mocy max. [W]	natężenie max. [A]		wydajność max. [m³/h]		poziom ciśnienia akustycznego w odległości 1,5* wlot [dB(A)] wylot [dB(A)]		masa [kg]	regulator	nr artykułu
			230V	400V	wyższa pręđ.	niższa pręđ.					
TRÓJFAZOWE 400V											
TRÓJFAZOWE 4 BIEGUNOWE											
HCTT/4-315-A	1360	150	-	0,34	2150	1820	58	64	14,4	RMT-1,5	43525730-01
HCTT/4-355-A	1350	200	-	0,46	3250	2520	59	61	15,8	RMT-1,5	43525740-01
HCTT/4-400-A	1380	300	-	0,8	4720	3900	64	68	16,5	RMT-1,5	43525750-01
HCTT/4-450-A	1350	500	-	0,95	6670	5250	68	71	23,5	RMT-1,5	43525760-01
HCTT/4-500-A	1380	660	-	1,6	8440	7000	72	76	25,4	RMT-2,5	43525770-01
HCTT/4-560-A	1380	1210	-	2,3	11400	9800	75	80	40	-	43525780-01
HCTT/4-630-A	1360	1600	-	3	15300	-	79	84	42,6	-	43525790-01
HCTT/4-710-A	1300	2200	-	4	20500	-	80	85	60	-	43525800-01
HCTT/4-800-A	1400	3 kW**	-	7,3	26600	-	85	90	67	falownik	43525810-01
HCTT/4-900-A	1400	4 kW**	-	9,5	35900	-	88	94	77	falownik	43525820-01
HCTT/4-1000-A	1400	5,5 kW**	-	12	44900	-	89	95	123	falownik	43525610-01
TRÓJFAZOWE 6 BIEGUNOWE											
HCTT/6-450-A	835	190	-	0,48	4400	3600	56	60	23,5	RMT-1,5	43525830-01
HCTT/6-500-A	830	250	-	0,57	5500	4500	60	63	25,4	RMT-1,5	43525840-01
HCTT/6-560-A	850	410	-	0,93	7900	6700	64	68	40	RMT-1,5	43525850-01
HCTT/6-630-A	810	600	-	1,18	9900	7800	66	70	42,6	RMT-1,5	43525860-01
HCTT/6-710-A	900	1100	-	3,3	14200	-	69	75	54	-	43525870-01
HCTT/6-800-A	930	0,75 kW**	-	2,5	17700	-	75	80	57	falownik	43525880-01
HCTT/6-900-A	930	1,1 kW**	-	3,5	23800	-	78	84	67	falownik	43525890-01
HCTT/6-1000-A	930	1,5 kW**	-	4,5	28800	-	79	85	108	falownik	43525900-01
TRÓJFAZOWE 8 BIEGUNOWE											
HCTT/8-710-A	670	370	-	1,2	10600	-	61	67	52	-	43525910-01
HCTT/8-800-A	700	0,37 kW**	-	1,9	13300	-	67	72	57	falownik	43525920-01
HCTT/8-900-A	700	0,55 kW**	-	2,3	18000	-	70	76	67	falownik	43525930-01
HCTT/8-1000-A	700	0,75 kW**	-	2,8	21700	-	71	77	105	falownik	43525940-01

Wymiary [mm]

Typ	∅A	□B	□C	∅D	∅E	F	G	H
315	640	560	450	315	12	40	70	341
355	760	630	535	355	12	40	80	361
400	760	630	535	400	12	40	80	361
450	895	710	590	450	14	40	110	410
500	895	710	590	500	14	40	110	410
560	1150	905	750	560	14	50	185	488
630	1150	905	750	630	14	50	185	488
710	1350	1100	840	710	14	50	200	551
800	1350	1100	840	800	14	50	200	732
900	1580	1250	950	900	14	50	200	756
1000	1580	1250	950	1000	14	50	200	756

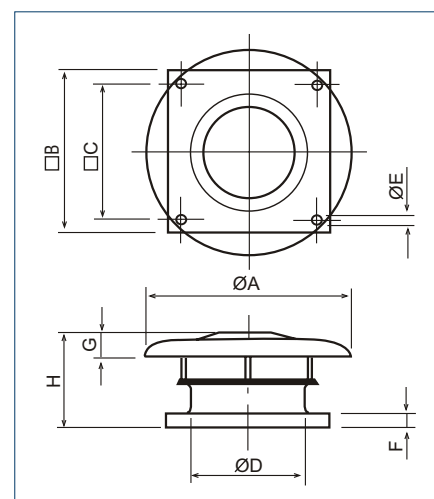

Charakterystyka akustyczna

Wywiew		63	125	250	500	1000	2000	4000	8000	
4-biegunowe	315	Wlot	41	57	51	73	64	63	58	51
		Wylot	41	53	54	72	62	60	56	50
	355	Wlot	45	56	56	60	65	66	63	56
		Wylot	46	56	63	61	63	64	61	54
	400	Wlot	50	59	58	65	66	69	68	59
		Wylot	51	60	63	65	65	66	66	57
	450	Wlot	52	60	60	67	72	71	69	61
		Wylot	52	63	64	68	70	70	68	61
	500	Wlot	55	64	71	74	80	79	74	66
		Wylot	55	65	72	74	76	75	71	64
	560	Wlot	57	65	75	81	82	81	76	69
		Wylot	57	69	73	76	78	78	75	67
	630	Wlot	63	70	72	79	83	83	81	73
		Wylot	62	73	75	77	80	78	76	71
	710	Wlot	71	82	90	89	93	89	82	73
		Wylot	72	86	89	87	89	86	80	72
	800	Wlot	76	91	96	99	99	95	87	79
		Wylot	77	93	95	94	94	92	86	77
900	Wlot	77	94	98	102	102	98	91	83	
	Wylot	77	96	98	97	97	95	89	80	
1000	Wlot	76	93	97	103	103	101	94	86	
	Wylot	78	94	96	97	100	99	93	85	

6-biegunowe	450	Wlot	42	48	54	58	62	64	58	50
		Wylot	44	50	56	58	60	61	57	49
	500	Wlot	45	52	57	60	65	66	62	53
		Wylot	46	53	59	61	63	63	59	52
	560	Wlot	48	56	62	64	70	70	65	57
		Wylot	49	59	63	64	66	67	63	55
	630	Wlot	51	57	65	68	73	74	70	60
		Wylot	53	61	66	67	69	70	68	59
	710	Wlot	61	72	80	79	83	79	72	63
		Wylot	62	76	79	77	79	76	70	62
	800	Wlot	66	81	86	89	89	85	77	69
		Wylot	67	83	85	84	84	82	76	67
	900	Wlot	67	84	88	92	92	88	81	73
		Wylot	67	86	88	87	87	85	79	70
	1000	Wlot	66	83	87	93	93	91	84	76
		Wylot	68	84	86	87	90	89	83	75

Wywiew		63	125	250	500	1000	2000	4000	8000	
8-biegunowe	710	Wlot	53	64	72	71	75	71	64	55
		Wylot	54	68	71	69	71	68	62	54
	800	Wlot	58	73	78	81	81	77	69	61
		Wylot	59	75	77	76	76	74	68	59
	900	Wlot	59	76	80	84	84	80	73	65
		Wylot	59	78	80	79	79	77	71	62
1000	Wlot	58	75	79	85	85	83	76	68	
	Wylot	60	76	78	79	82	81	75	67	

Nawiew		63	125	250	500	1000	2000	4000	8000	
4-biegunowe	315	Wylot	39	61	62	77	68	66	58	52
		Wlot	38	59	65	69	65	60	55	50
	355	Wylot	41	61	64	69	72	71	64	56
		Wlot	40	62	66	67	69	66	61	52
	400	Wylot	47	67	71	75	78	76	69	59
		Wlot	46	66	68	72	74	71	65	54
	450	Wylot	50	71	75	79	82	79	72	64
		Wlot	47	72	72	77	78	73	67	59
	500	Wylot	57	75	80	84	86	83	76	68
		Wlot	56	74	79	81	82	78	71	65
	560	Wylot	58	85	84	87	90	87	79	71
		Wlot	58	80	84	82	85	82	75	66
	630	Wylot	63	86	90	91	94	91	83	73
		Wlot	64	83	89	87	88	85	77	68
	710	Wylot	73	89	92	93	96	92	84	76
		Wlot	71	88	89	87	88	85	78	70
	800	Wylot	73	89	95	100	100	97	91	84
		Wlot	70	91	94	94	93	90	83	75
900	Wylot	85	93	99	104	104	101	95	88	
	Wlot	73	95	97	97	96	94	88	80	
1000	Wylot	78	92	99	104	105	104	98	90	
	Wlot	72	94	95	97	99	97	91	83	

6-biegunowe	450	Wylot	49	60	65	67	70	67	60	52
		Wlot	44	58	66	65	65	62	55	47
	500	Wylot	54	65	69	71	74	71	62	54
		Wlot	52	63	68	69	69	66	59	50
	560	Wylot	56	70	74	75	78	75	67	59
		Wlot	54	70	72	71	73	70	63	54
	630	Wylot	59	73	78	77	80	77	68	59
		Wlot	57	72	76	73	75	72	64	54
	710	Wylot	63	79	82	83	86	82	74	66
		Wlot	60	77	78	76	77	74	67	59
	800	Wylot	63	79	85	90	90	87	81	74
		Wlot	60	81	84	84	83	80	73	65
	900	Wylot	75	83	89	94	94	91	85	78
		Wlot	63	85	87	87	86	84	78	70
	1000	Wylot	68	82	89	94	95	94	88	80
		Wlot	62	84	85	87	89	87	81	73

Nawiew		63	125	250	500	1000	2000	4000	8000	
8-biegunowe	710	Wylot	55	71	74	75	78	74	66	58
		Wlot	52	69	70	68	69	66	59	51
	800	Wylot	55	71	77	82	82	79	73	66
		Wlot	52	73	76	76	75	72	65	57
	900	Wylot	67	75	81	86	86	83	77	70
		Wlot	55	77	79	79	78	76	70	62
1000	Wylot	60	74	81	86	87	86	80	72	
	Wlot	54	76	77	79	81	79	73	65	

Charakterystyki pracy - wywiew (typ B)

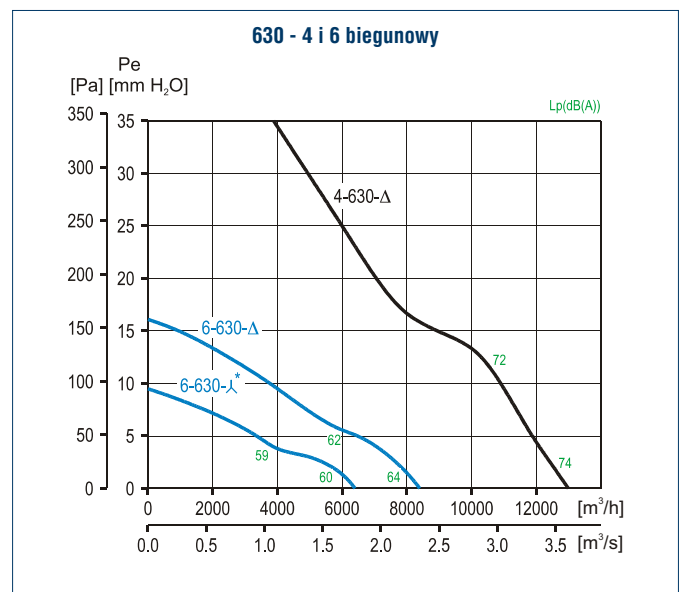
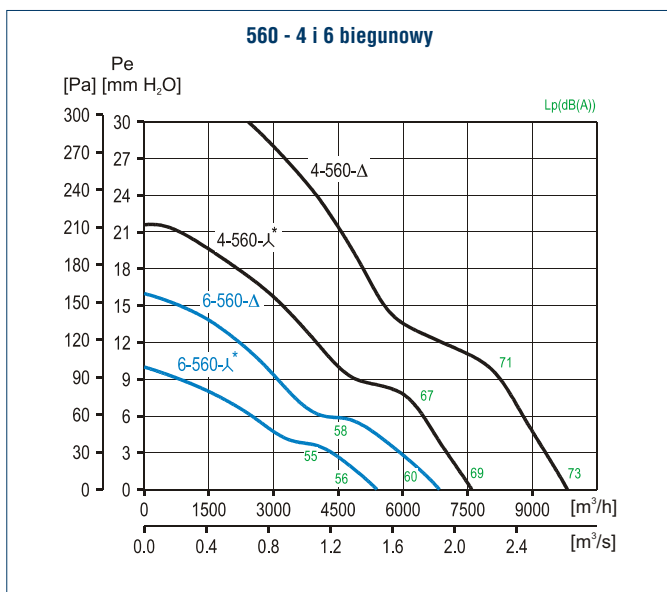
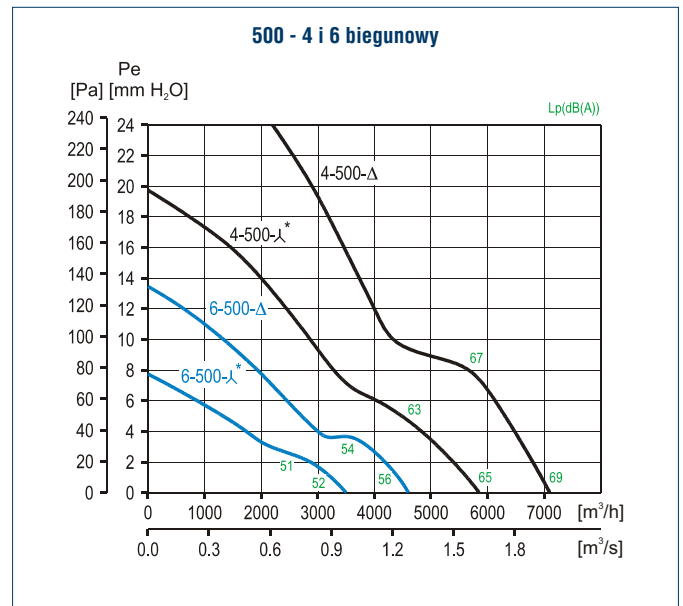
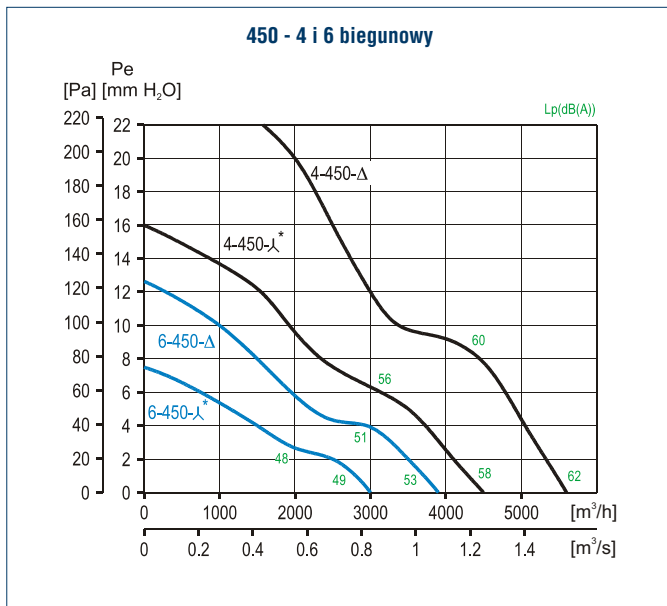
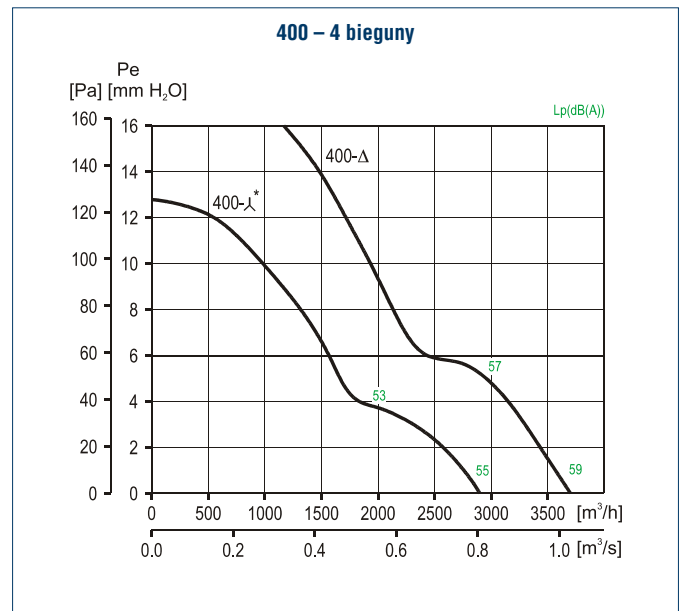
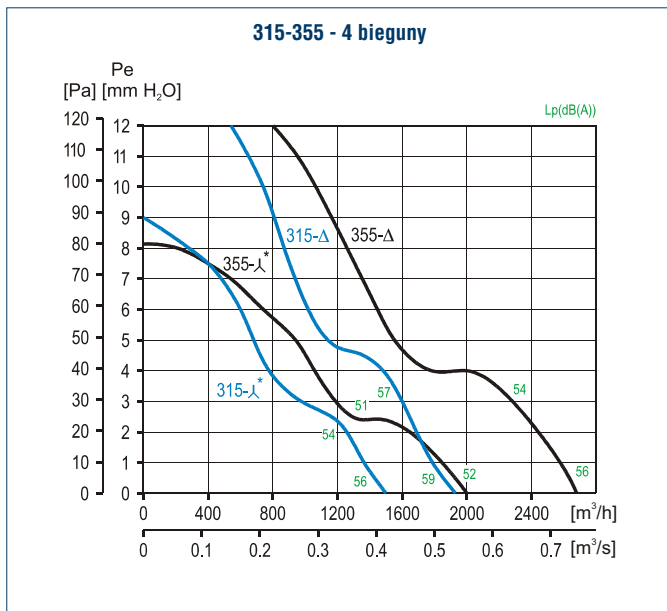

Charakterystyki prac - wywiew (typ B)

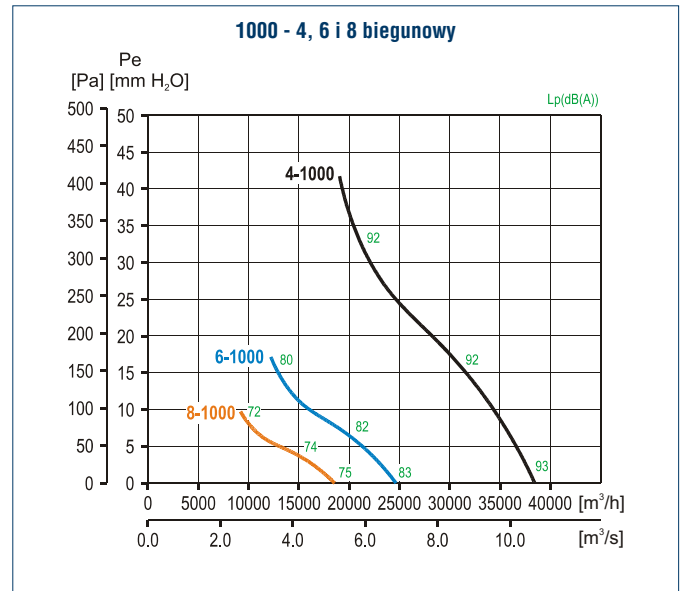
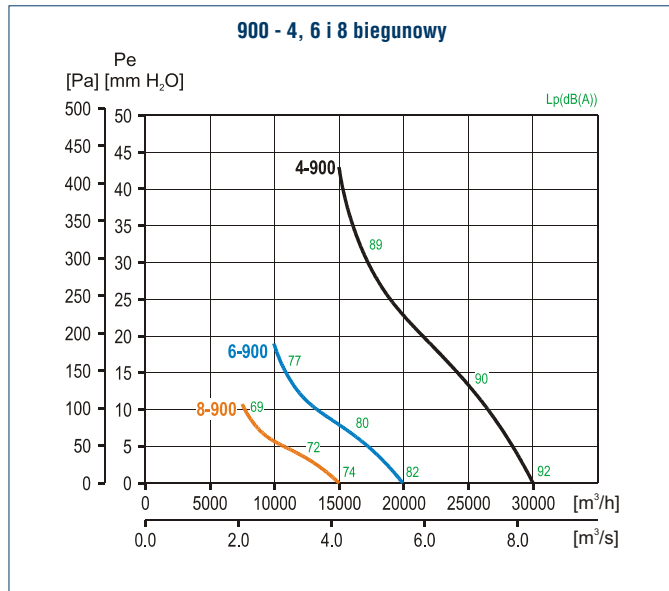
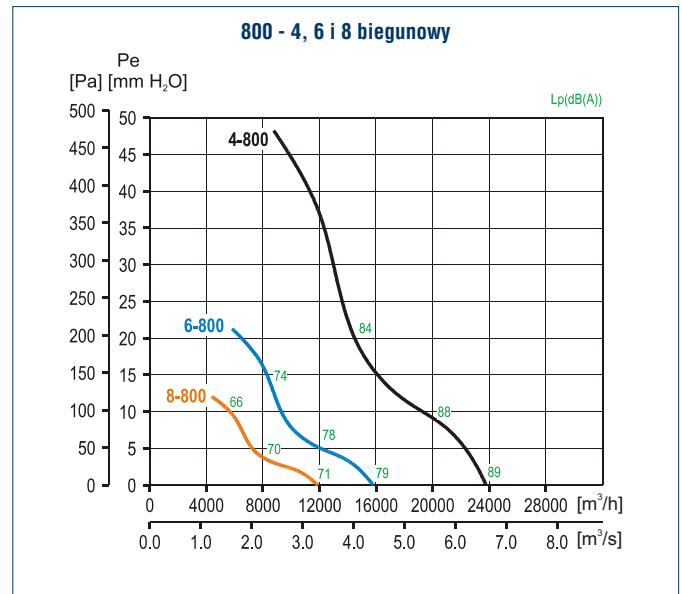
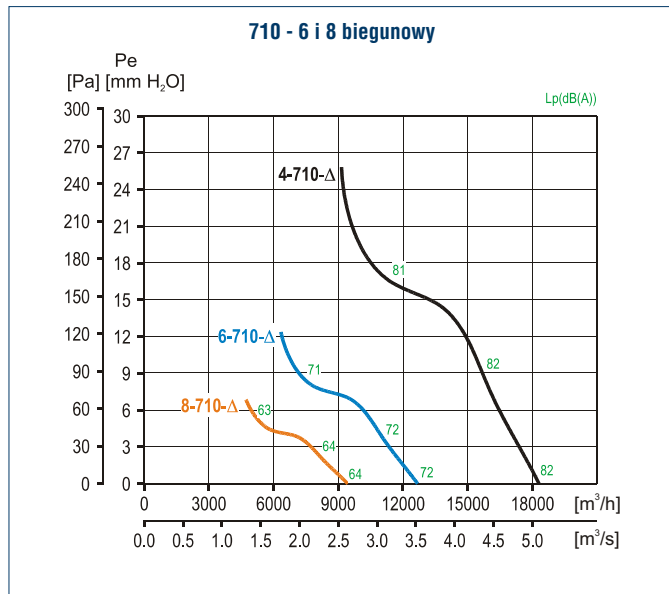

Charakterystyki prac - nawiew (typ A)

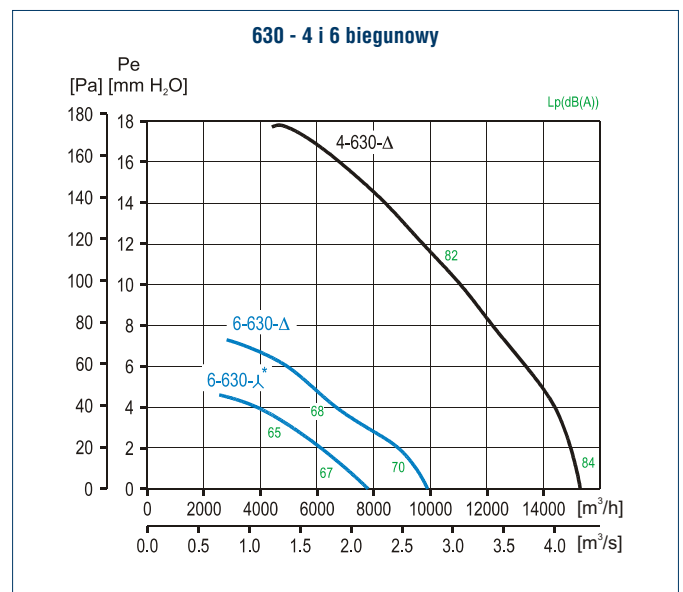
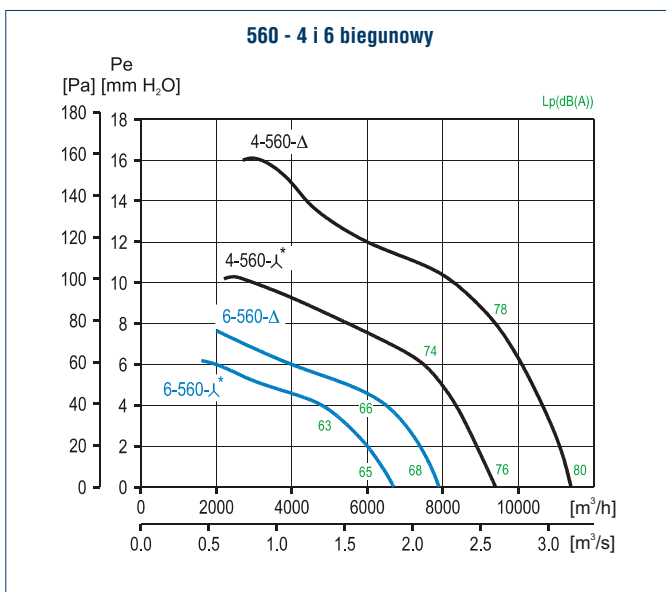
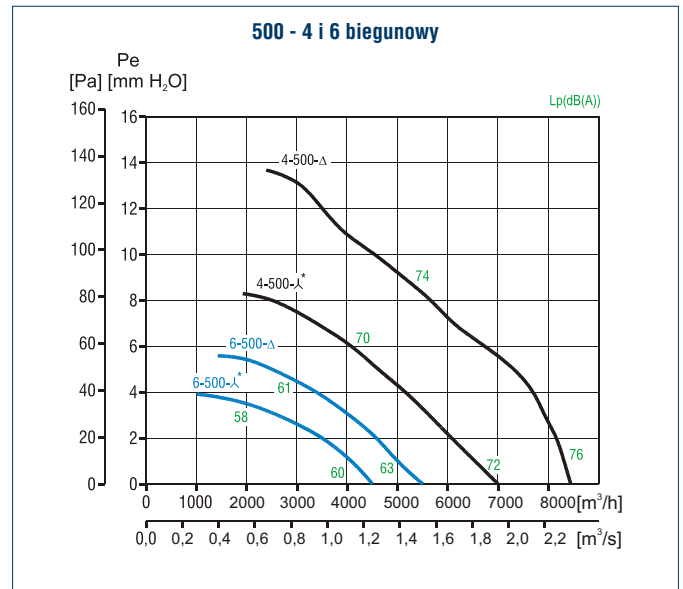
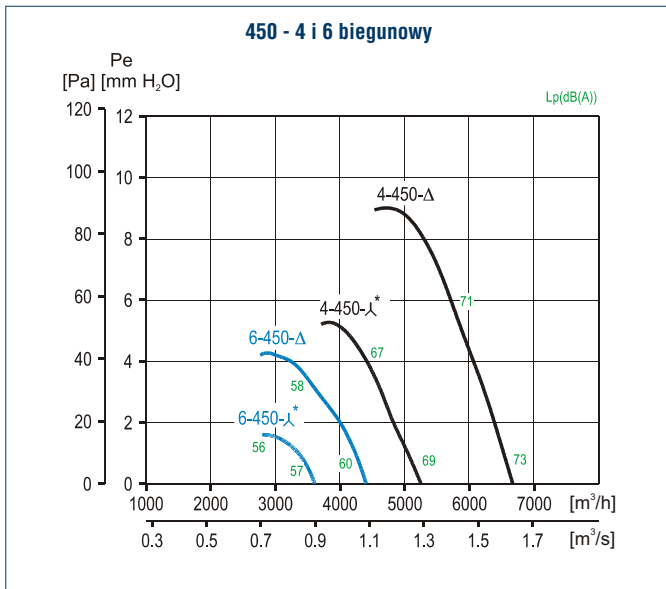
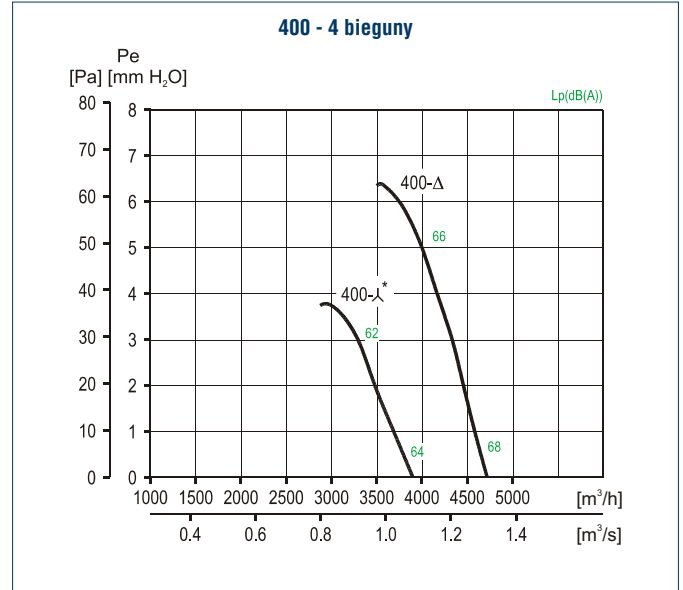
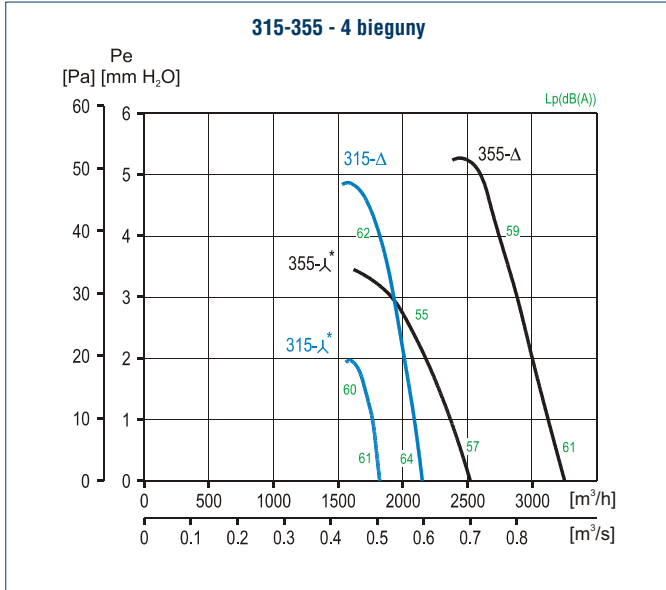

Charakterystyki prac - nawiew (typ A)

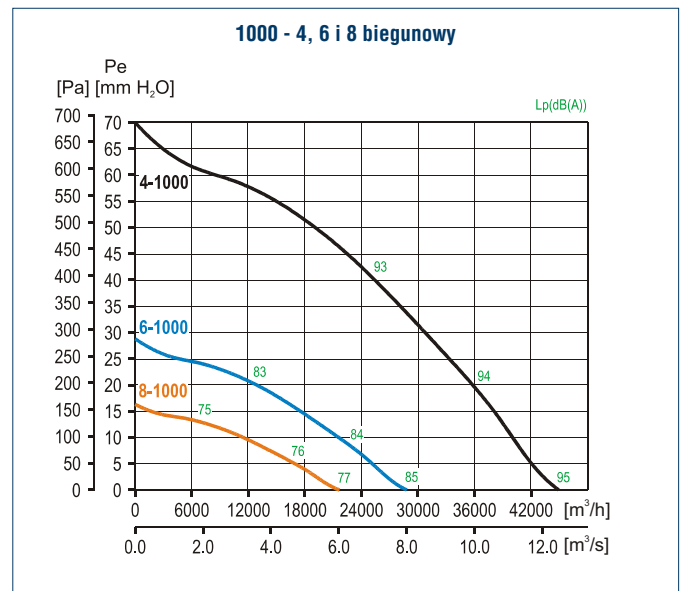
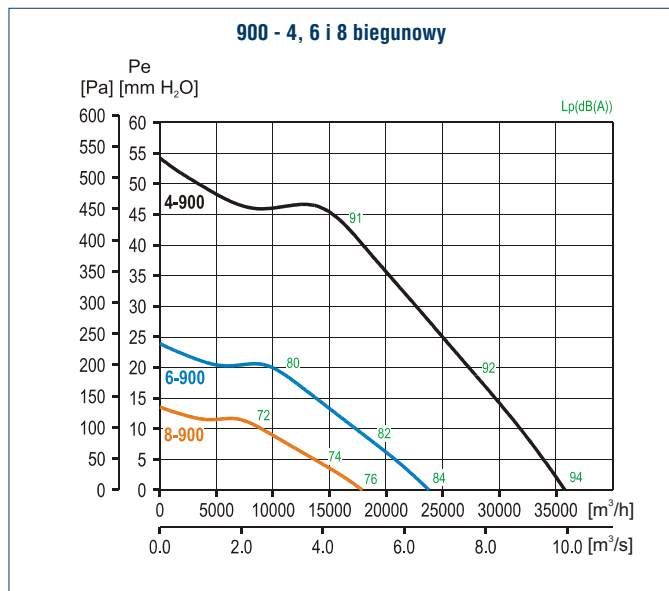
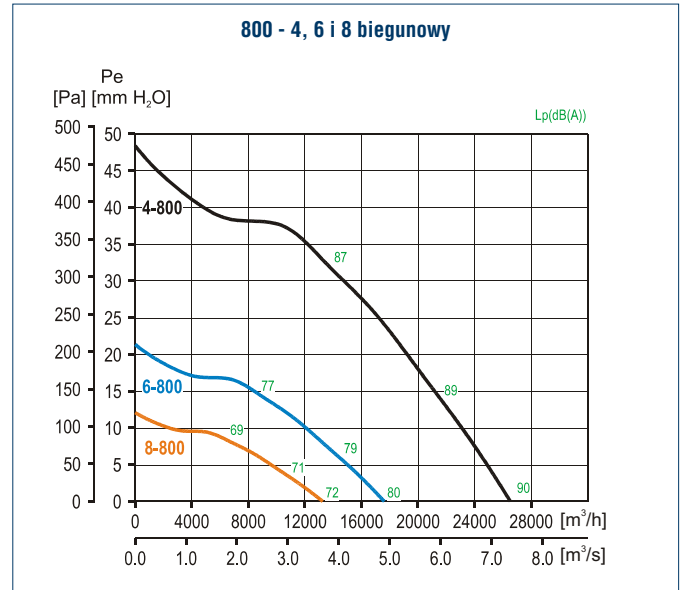
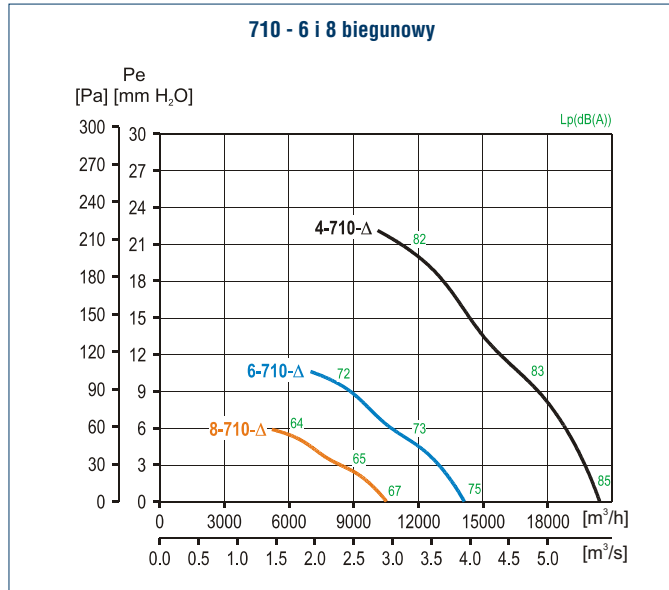

Wyposażenie dodatkowe

Typ	Podstawa dachowa	Podstawa dachowa tłumiąca	Złącze	Kłapa zwrotna	Króciec	Złącze przeciwdrganiowe
	1	2	3	4	5	6
315	RS-560	RSA-560	JPA-560	JCA-560	JBR-560	JAЕ-560
355	RS-630	RSA-630	JPA-630	JCA-630	JBR-630	JAЕ-630
400						
450	RS-710	RSA-710	JPA-710	JCA-710	JBR-710	JAЕ-710
500						
560	RS-905	RSA-905	JPA-905	JCA-905	JBR-905	JAЕ-905
630						
710	RS-1100	RSA-1100	JPA-1100	JCA-1100	JBR-1100	JAЕ-1100
800						
900	RS-1250	RSA-1250	JPA-1250	JCA-1250	JBR-1250	
1000						

