

Zastosowanie

Promieniowy wentylator niskociśnieniowy, przeznaczony do transportu agresywnych gazów o niskim stopniu zapylenia. Znajdują zastosowanie w różnorodnych instalacjach wentylacji mechanicznej, do tłoczenia powietrza w procesach produkcyjnych, systemach wentylacji, w urządzeniach chłodniczych i klimatyzacyjnych, suszarniach, digestoriach. Znajdują zastosowanie w centralach wentylacyjnych.

Konstrukcja

Wirnik z łopatkami pochylonymi do przodu, zgrzewany z nierdzewnej blachy stalowej 1.4301(AISI304). Wirnik wyważony dynamicznie wg ISO 1940. Obudowa spawana z nierdzewnej blachy stalowej 1.42301(AISI304). Wentylatory standardowo wykonywane w figurze LG.

Silnik elektryczny

Asynchroniczny trójfazowy 230/400 50Hz lub 400V 50Hz, lub jednofazowy 230V 50Hz z kondensatorem. Silniki wykonane zgodnie ze standardami IEC 60072 i IEC 60034, posiadają znak CE. Klasa izolacji F, stopień ochrony IP55. Silniki na inne napięcie i częstotliwość, o podwyższonym stopniu ochrony, przystosowane do regulacji napięciowej lub przetwornicą.

Częstotliwości, z niezależnym chłodzeniem, z czujnikami (bimetalowymi lub pozystorowymi) mogą być dostarczane na życzenie.

Schemat podłączenia elektrycznego rys. 11, 12 str. 735.

Dane techniczne

Typ	specyfikacja	moc silnika [kW]	prędkość znam. [obr./min]	napięcie [V]	natężenie znam. [A]	wydajność max. [m³/h]	sprężystość max. [Pa]
GFS/2-97/42-003S LG	230V 50Hz	0,03	2800	230V	0,4	300	220
GFS/2-97/42-005T LG	230/400V 50Hz	0,05	2800	400Y	0,25	300	220
GFS/2-108/42-009S LG	230V 50Hz	0,09	2800	230V	0,9	390	320
GFS/2-108/42-009T LG	230/400V 50Hz	0,09	2800	400Y	0,32	390	320
GFS/2-120/52-012S LG	230V 50Hz	0,12	2800	230V	1,0	560	410
GFS/2-120/52-012T LG	230/400V 50Hz	0,12	2800	400Y	0,35	560	410
GFS/2-133/62-018S LG	230V 50Hz	0,18	2800	230V	1,5	700	550
GFS/2-133/62-018T LG	230/400V 50Hz	0,18	2800	400Y	0,55	700	550
GFS/2-146/62-025S LG	230V 50Hz	0,25	2800	230V	1,8	800	720
GFS/2-146/62-025T LG	230/400V 50Hz	0,25	2800	400Y	0,65	800	720
GFS/2-160/62-037S LG	230V 50Hz	0,37	2800	230V	3,0	850	870
GFS/2-160/62-037T LG	230/400V 50Hz	0,37	2800	400Y	1	850	870
GFS/2-180/62-075S LG	230V 50Hz	0,75	2800	230V	4,9	1800	1050
GFS/2-180/62-075T LG	230/400V 50Hz	0,75	2800	400Y	1,9	1800	1050
GFS/2-200/74-110S LG	230V 50Hz	1,1	2800	230V	7,0	2350	1300
GFS/2-200/74-110T LG	230/400V 50Hz	1,1	2800	400Y	2,5	2350	1300
GFS/4-200/74-037S LG	230V 50Hz	0,37	1400	230V	3,1	1400	400
GFS/4-200/74-037T LG	230/400V 50Hz	0,37	1400	400Y	1,2	1400	400
GFS/2-225/104-300T LG	230/400V 50Hz	3,0	2900	400Y	6,1	4500	1600
GFS/4-225/104-055T LG	230/400V 50Hz	0,55	1400	400Y	1,7	2100	400
GFS/2-250/114-550T LG	400V 50Hz	5,5	2900	400Δ	10,4	6100	1750
GFS/4-250/114-075T LG	230/400V 50Hz	0,75	1400	400Y	2	3300	470
GFS/2-280/102-750T LG	400V 50Hz	7,5	2900	400Δ	13,9	7000	2000
GFS/4-280/102-075T LG	230/400V 50Hz	0,75	1400	400Y	2	3500	500
GFS/4-315/143-300T LG	400V 50Hz	3,0	1400	400Δ	6,6	6700	750
GFS/6-315/143-075T LG	230/400V 50Hz	0,75	920	400Y	2,1	4400	350
GFS/4-400/183-750T LG	400V 50Hz	7,5	1400	400Δ	14,6	11600	1200
GFS/6-400/183-220T LG	230/400V 50Hz	2,2	920	400Y	4,8	800	500
GFS/6-450/203-550T LG	400V 50Hz	5,5	950	400Δ	11,8	14500	640

Wymiary [mm]

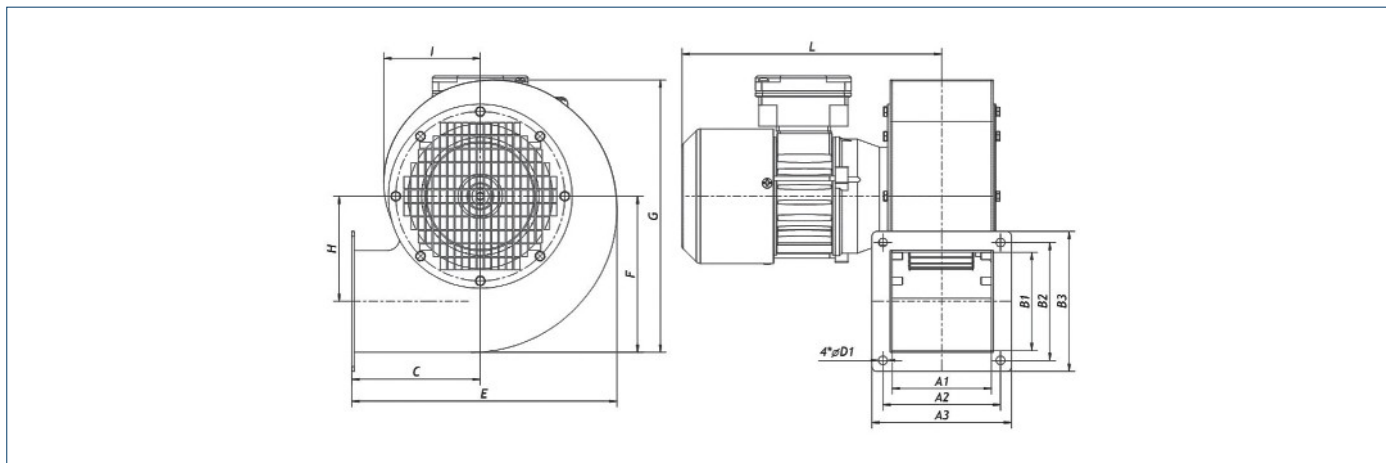

Typ	A1	A2	A3	B1	B2	B3	C	D1	E	F	G	H	I	L*
GFS-2-97/42-003S	64	76	90	64	76	90	97	6,1	199	115	200	82	70	203
GFS-2-97/42-005T	64	76	90	64	76	90	97	6,1	199	115	200	82	70	203
GFS-2-108/42-009S	64	76	90	64	76	90	97	6,1	199	115	200	82	70	203
GFS-2-108/42-009T	64	76	90	64	76	90	97	6,1	199	115	200	82	70	203
GFS-2-120/52-012S	81	96	114	80	96	114	105	7,1	219	127	222	86	79	227
GFS-2-120/52-012T	81	96	114	80	96	114	105	7,1	219	127	222	86	79	229
GFS-2-133/62-018S	91	115	130	87	105	120	113	7,1	238	142	245	97	85	238
GFS-2-133/62-018T	91	115	130	87	105	120	113	7,1	238	142	245	97	85	236
GFS-2-146/62-025S	91	115	130	87	105	120	121	7,1	258	155	270	110	95	253
GFS-2-146/62-025T	91	115	130	87	105	120	121	7,1	258	155	270	110	95	238
GFS-2-160/62-037S	90	110	126	107	120	140	130	7,1	281	170	296	115	104	263
GFS-2-160/62-037T	90	110	126	107	120	140	130	7,1	281	170	296	115	104	241
GFS-2-180/62-075S	100	130	155	122	130	155	143	7,1	312	192	334	129	117	291
GFS-2-180/62-075T	100	130	155	122	130	155	143	7,1	312	192	334	129	117	279
GFS-2-200/74-110S	119	143	163	137	160	180	180	7,1	370	213	374	143	134	208
GFS-2-200/74-110T	119	143	163	137	160	180	180	7,1	370	213	374	143	134	300
GFS-4-200/74-037S	119	143	163	137	160	180	180	7,1	370	213	374	143	134	277
GFS-4-200/74-037T	119	143	163	137	160	180	180	7,1	370	213	374	143	134	255

* wymiary orientacyjne

Wymiary [mm]

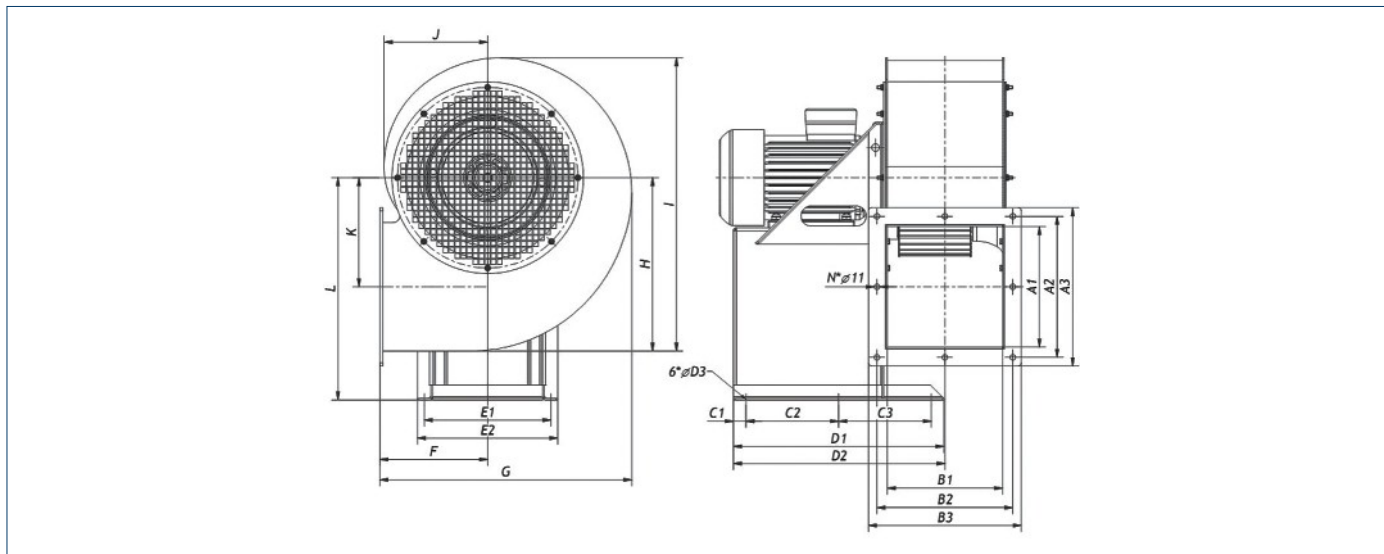

Typ	A1	A2	A3	B1	B2	B3	N	C1	C2	C3	D1
GFS-2-225/104-300S	136	161	181	148	173	193	4	20	115	115	350
GFS-4-225/104-055T	136	161	181	148	173	193	4	20	115	115	350
GFS-2-250/114-550T	190	230	255	168	210	235	4	20	170	170	380
GFS-4-250/114-075T	190	230	255	168	210	235	4	20	170	170	380
GFS-4-315/143-300T	240	281	315	230	271	305	8	25	185	185	422
GFS-6-315/143-075T	240	281	315	230	271	305	8	25	185	185	422
GFS-4-400/183-750T	274	315	349	289	332	366	8	30	230	230	533
GFS-6-400/183-220T	274	315	349	289	332	366	8	30	230	230	533
GFS-6-450/203-550T	260/297	345	385	270/319	369	409	12	20	250	277,5	568

Typ	D2	D3	E1	E2	F	G	H	I	J	K	L
GFS-2-225/104-300S	350	9,2	245	265	182	374	217	382	139	143	310
GFS-4-225/104-055T	350	9,2	245	265	182	374	217	382	139	143	290
GFS-2-250/114-550T	380	11	326	350	202	418	252	431	162	151	395
GFS-4-250/114-075T	380	11	326	350	202	418	252	431	162	151	343
GFS-4-315/143-300T	420	12	253	280	215	502	346	584	207	218	443
GFS-6-315/143-075T	420	12	253	280	215	502	346	584	207	218	433
GFS-4-400/183-750T	540	14	394	430	282	661	434	756	268	289	535
GFS-6-400/183-220T	540	14	394	430	282	661	434	756	268	289	515
GFS-6-450/203-550T	568	14	334	370	312	715	456	801	289	300	545

Charakterystyki pracy

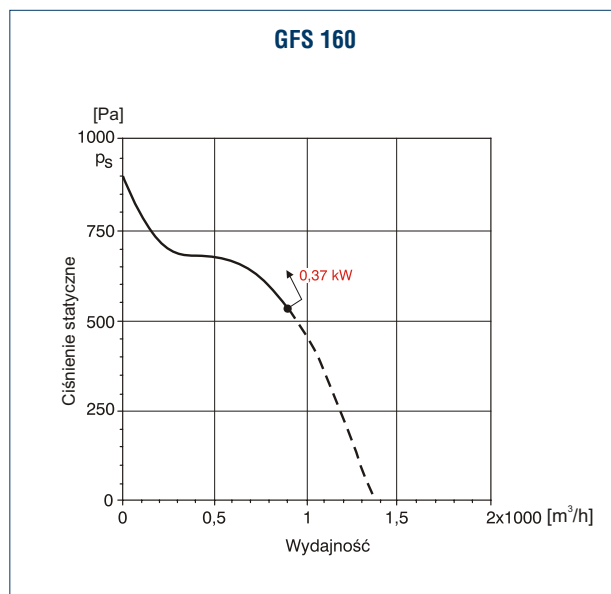
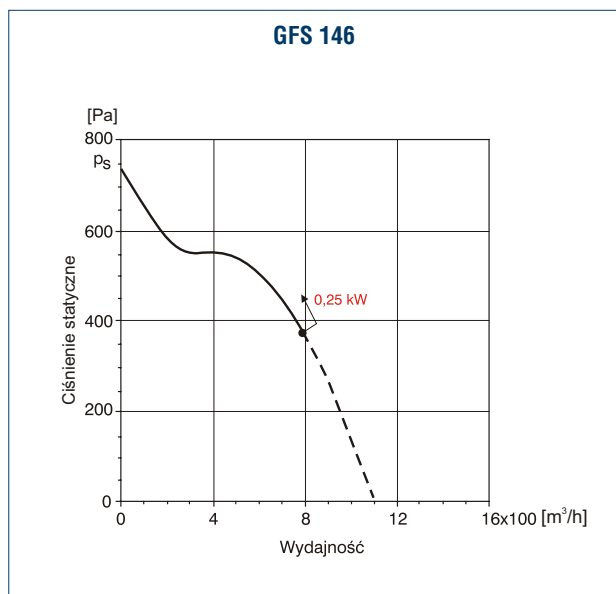
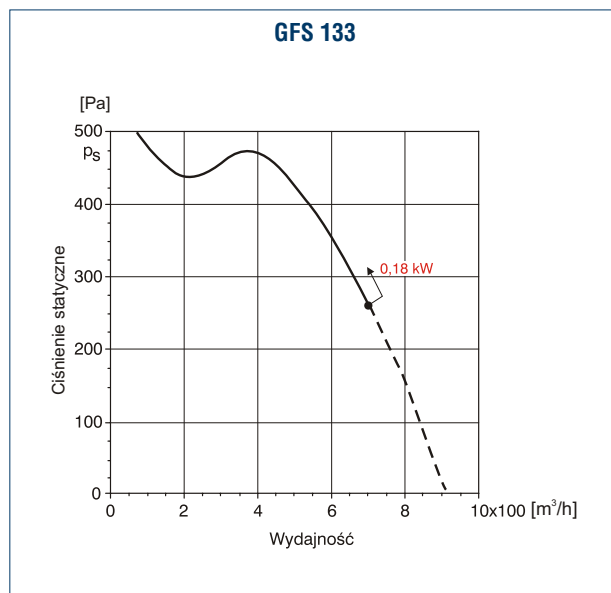
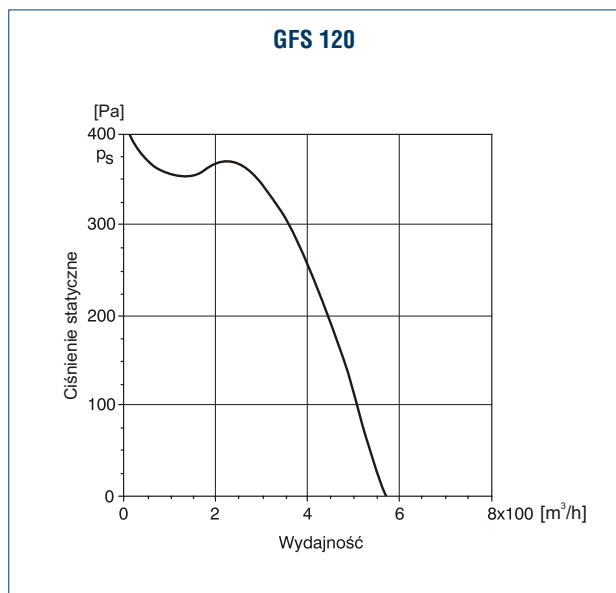
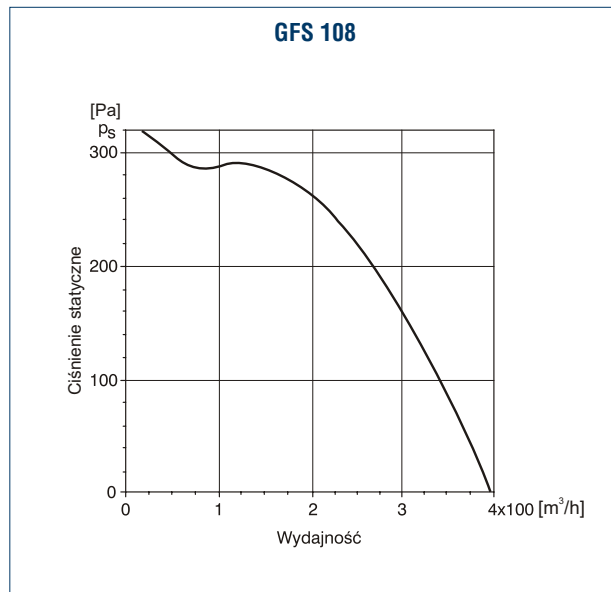
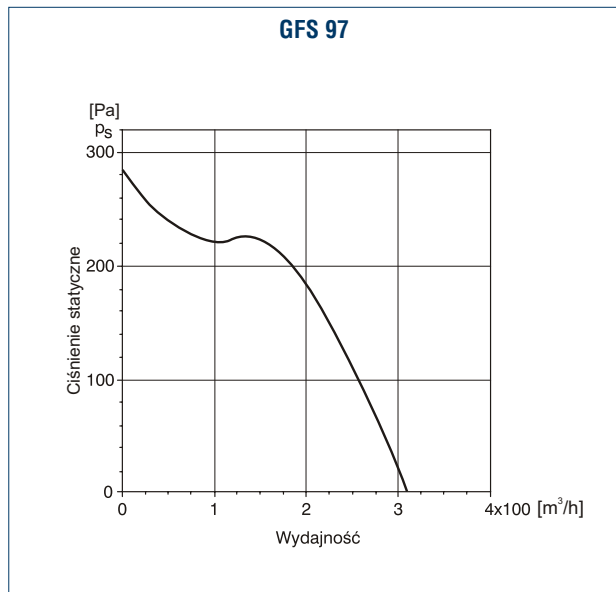

Charakterystyki pracy

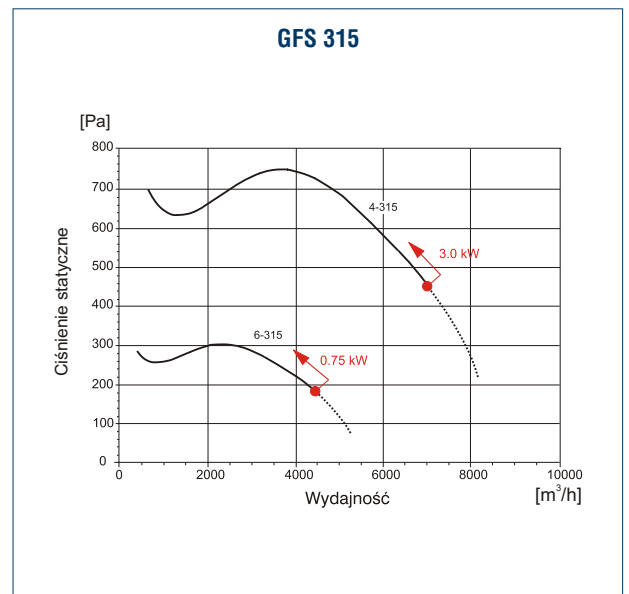
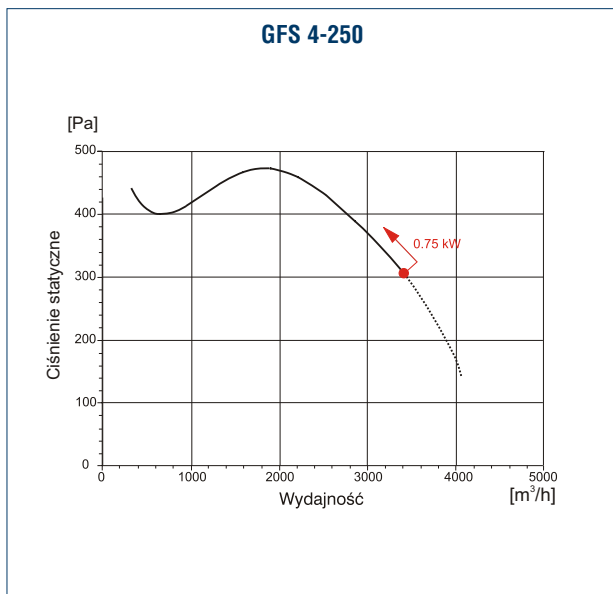
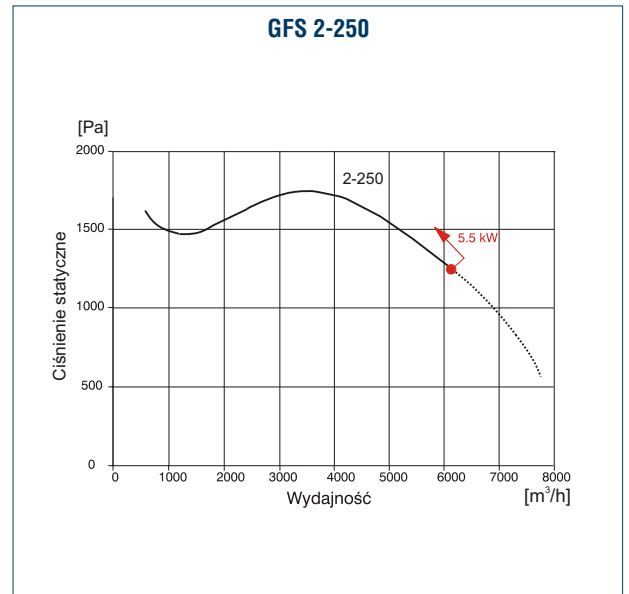
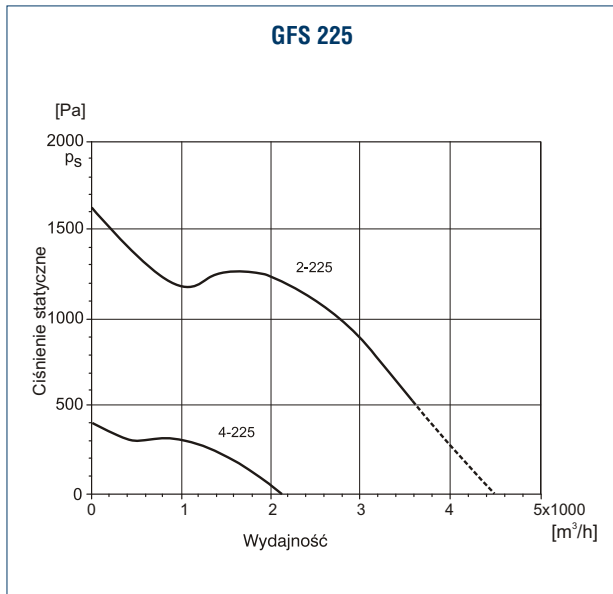
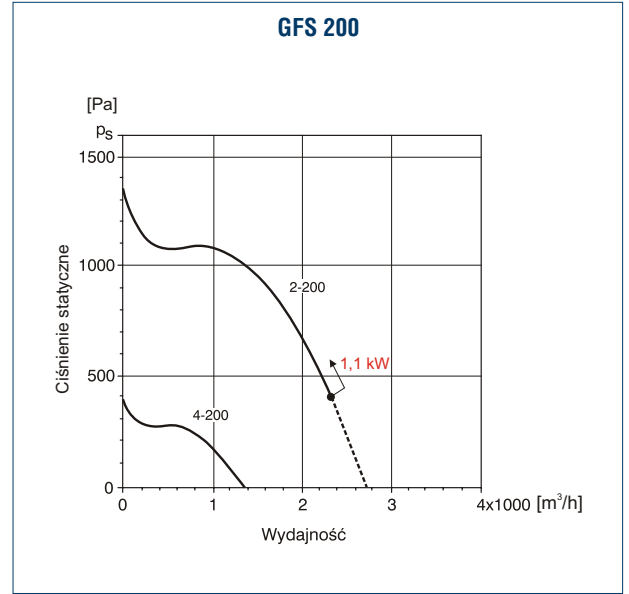
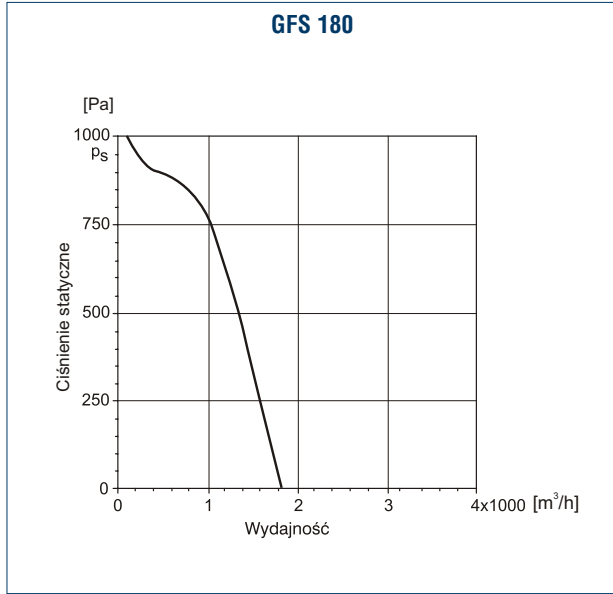

Charakterystyki pracy

